

NEST[®]

PRODUCT CATALOGUE

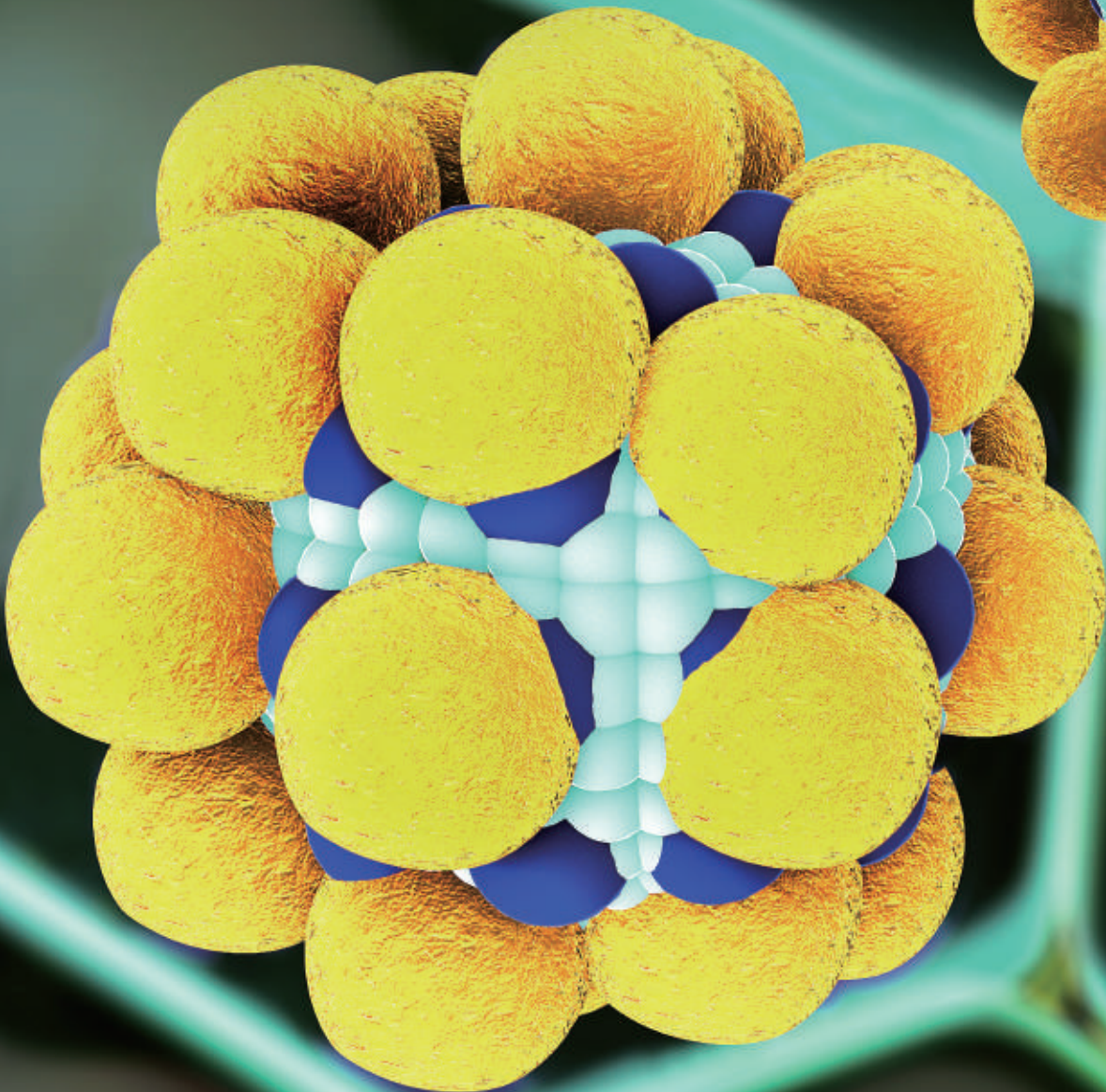



Have you checked out the new designs and functions on our website?



COA/COC
Download



Documents
Download



Cross-Reference
Tool



PCR Product
Compatibility
Reference Tool



Closed System
Customization

Exploring more in-depth information?

Missed out specific details?

Scann the QR codes above to experience NEST online services.

You can also visit <https://www.cell-nest.com/>

Contents

I Cytology

Cytology 06

Cell Culture Plate	07
Cell Culture Insert	09
Glass Bottom Cell Culture Dish / Plate	11
Cell Culture Dish	13
Cell Culture Flask	15
Cell Scraper / Cell Strainer / 50mL Mini	
Bioreactor	17

II Bioprocessing Solutions

Large Scale Cultivation 18

Erlenmeyer Flask	19
Erlenmeyer Flask, High Efficiency	23
Accessories	25
Erlenmeyer Flask Closed System Solution	26
Accessories	28
BioFactory	29
Biofactory Closed System Solution	32
Accessories	35
Square Bottle & Closed System Solution	37
Carboy	41
Accessories	42

III Liquid Handling

Biobank System 43

Cryogenic Tubes	44
SBS Format Cryogenic Tubes	48
Cap Inserts / Cryogenic Box	50
Defrosting Device	51
Vertical Freezer Racks	52
Sample Freezing Recommendations	53

Liquid Transfer 54

Automation Tips	55
Stackable Tip Refil	58
Pipette Tips	60
Vacuum Filtration System	62
Syringe Filter	65
Microcentrifuge Tube / Micro Tube Box	66
15 / 50 mL Centrifuge Tube	67
Peripheral Blood Lymphocyte Separation Tube	68
250 / 500 mL Centrifuge Tube	70
Centrifuge Tube Closed System Solution	71
Pasteur Pipette	72
Serological Pipette	73
Reagent Reservoir / Reservoir	74
Round Storage Bottle	75
Sample Vial	76
Cluster tube	77

IV Biological Testing

Molecular Biology 78

ELISA Plate	79
Deep Well Plate	80
8-Strip PCR Tube & Tube & Cap	83
PCR 96 Well Plate	85
PCR Adapter Table	88

Bacteria 92

Petri Dish	93
L-Spreader & Inno-culating Needle / Loop	94

V Medical Consumables

Disposable Swab	96
Viral Transport Medium	97
Inactivation Transport Medium	98
Saline Transport Medium	99
AMIES Transport Medium	100
Universal Transport Medium	101
Disposable Intranasal Atomization Device	102
Dry Saliva Collection Kit	104
Saliva/gargle Collection Kit	105

VI Pharmaceutical Packaging

AccureVial™ COP Bottle	108
Pre-filling Disposable Glass Intranasal Atomization Device	109
Pre-filling COP Syringe with Luer Lock	110
Pen Injector	111

IX Other

Lab Safety 114

Nitrile Examination Glove	115
Latex Examination Glove	117
Nonwoven Mask	119
Mushroom Cap & Non-woven Shoe Cover ...	120

Lab Instruments 121

7° Digital Nutating Mixer	122
Mini Vortex Mixer	122
Variable Speed Tube Revolver with Digital Display	123
CO ₂ Orbital Shaker	124
Standard Mini Roller	125
Automatic Decapper Instruction manual	126
Centrifuge	127
Mini Dry Bath	127
Label Printer	128
Sample Management Software	129
Single-Rack Reader	130
Multi-Rack Reader	131
Handheld Decapper for Cryogenic Vials	132
Cell Thawing Device	133
Pipette	134

CONTENTS

COMPANY PROFILE

A leading life science plastic consumables manufacturer.

Established in 2009, Wuxi NEST Biotechnology Co., Ltd. (NEST) is renowned for its brand "NEST" and is dedicated to the research, development, and manufacturing of high-quality life sciences products. As our International business expands, our products have been successfully exported to numerous countries such as North America, Europe, Japan, Korea, India, and more.

2011, NEST passed the standard of the quality management system of ISO 9001.

2014, NEST passed the standard of the quality management system of ISO 11137.

2016, NEST passed the standard of the quality management system of ISO 13485.

2020, NEST obtained the medical device production license.

In addition to these certifications, we also gained CE and FDA standards.

NEST Scientific Inc. (USA)

With the development of the business, we have established deep cooperation and built strong relationships with overseas customers in order to send the products to customers in North America more quickly. Nest Scientific Inc., a branch of Wuxi NEST Biotechnology Co., Ltd., was established in New Jersey, the USA in 2013. Composed by a professional team with rich experience in training and sales skills, NEST Scientific USA can provide professional training as well as great communication with customers in-depth in order to understand customers' demands better and quicker. In 2022, NEST is opening a new 48,000ft² warehouse located in Phoenix, AZ. This new warehouse allows for more space to receive in and stock items as well as lower shipping costs for distributors on the west coast.

To further expand our footprints globally, and to respond the request for more timely service from NEST's accumulating industrial customers including CDMOs, vaccine plants and third-party testing companies, etc., we are setting up subsidiaries in Netherland, UAE and Japan to duplicate our US successful experience.

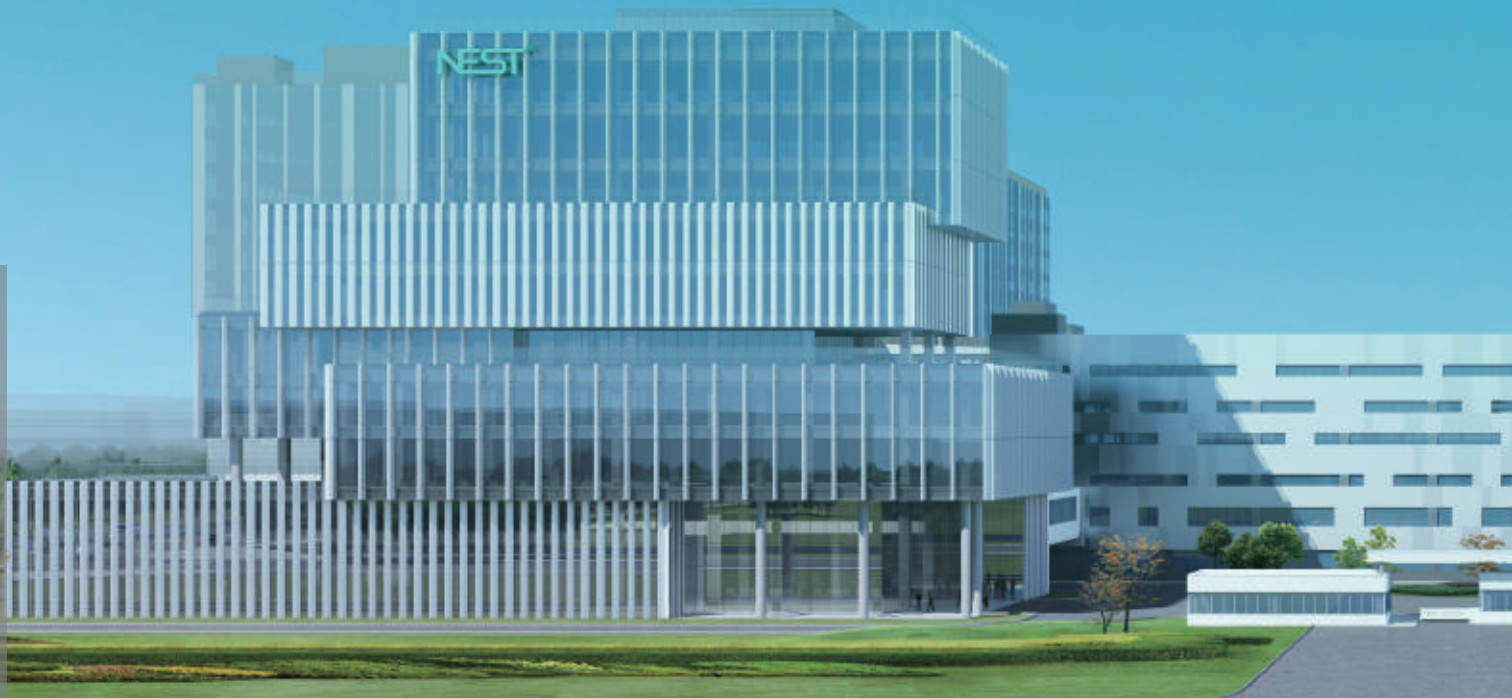

Overseas Branches

NEST brand is continuously expanding its overseas market. With a steady increase in overseas business volume, NEST's presence has extended to the Americas, Europe, the Middle East, and East Asia. In 2013, the US branch was officially established, and a new warehouse was completed in the US in 2022. Additionally, NEST has subsidiaries in Rotterdam, the Netherlands; Sharjah, the United Arab Emirates; and Tokyo, Japan. These subsidiaries have successfully provided integrated storage, transportation, and sales services, ensuring NEST brand's supply in overseas markets. Currently, NEST products are sold in many countries worldwide, including North America, Europe, Japan, South Korea, and India.

Customized Consumables

NEST offers a wide range of consumables, including plates, bottles, dishes, tubes, and other cell culture consumables. You can freely choose our standardized products in specific packaging or request customized solutions such as closed systems. Should you have any requirements, please feel free to contact us.



Wuxi NEST Biotechnology Co., Ltd.



Your best choice for medical laboratory consumables.

NEST is dedicated to researching and developing innovative plastic consumables suitable for life sciences research and medical establishments. There are more than 600 plastic consumables that can be widely used for cell culture, molecular biology, immunoassays, liquid handling, and storage such as cell culture plates, Erlenmeyer flasks, BioFactory, pipette tips, etc. More than 100 medical plastic consumables and reagents can be used in molecular diagnosis and vaccination, such as disposable samplers, transport media, swabs, nucleic acid extraction kits, and disposable intranasal atomization devices. In order to provide a more comprehensive and convenient service, we work closely with our affiliated company Wuxi Tech-star Technology Co., Ltd. We also provide lab instruments such as centrifuges, metal baths, BioBank, etc.



Quality Guaranteed Experienced team & a complete plastic consumables production line.

A complete plastic consumables production line is in NEST's possession, where all the procedures from mold-making, injection molding to sterilization, are done efficiently in our own factory. Precision molds, high-quality raw material, and advanced equipment are in position to manufacture products and perform quality testing under strict and comprehensive rules, ensuring our products meet the highest quality and performance standards expected by hospitals, research institutions, and industrial, clinical laboratories, to which we supply products.

- **Excellent mold-making ability.**

With over 30 years' experience, our senior R&D team utilize high-quality mold-making equipment imported from Germany in combination of professional mold analysis software to accomplish precision molds development tasks.

- **Injection molding in Class 10,000 and Class 100,000 cleanroom in strict quality control.**

Owing to the 2700 m² Class 10,000 cleanroom and 6800 m² Class 100,000 cleanroom, all-electric high-speed injection molding machines imported from Japan and the raw material which is in line with USP Class VI requirements, production and quality control are performed strictly in accordance with the corresponding SOP.

- **Sterilization by electronic beam irradiation.**

The Rhodotron TT200 electron accelerator, whose sterilization process has been certified by the ISO 11137 quality system, was imported from the IBA company, a world leader in the E-Beam sterilization industry in Belgium. Compared with sterilization by cobalt 60 or ethylene oxide sterilization, sterilization by electronic beam irradiation is more efficient and safer which requires less time and will not produce any chemical residue.



ISO 9001



ISO 13485



ISO 11137



JSDA



CE



CE
(Medical Consumables)



FDA

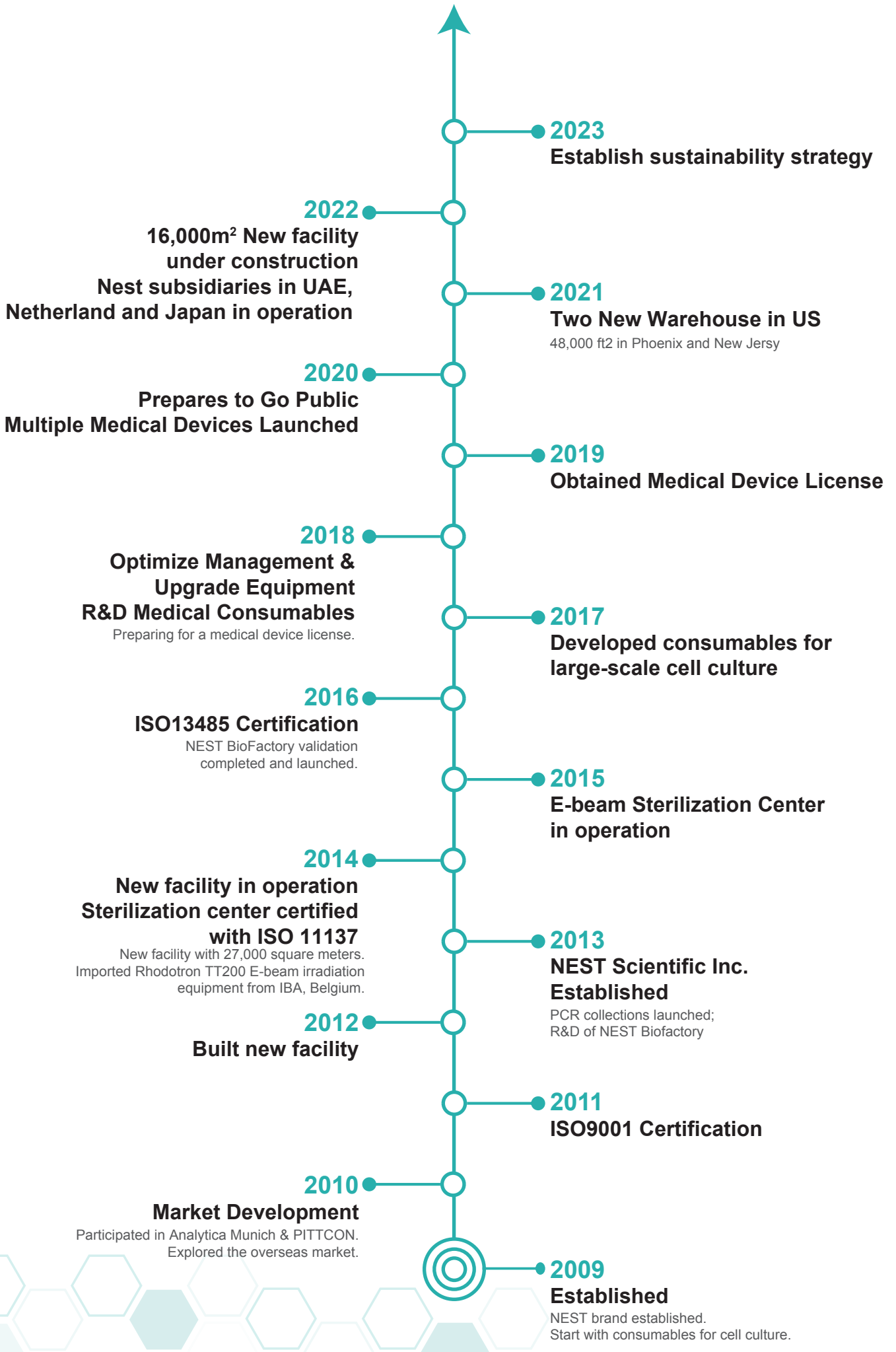



Cytology

Cell Culture Plate

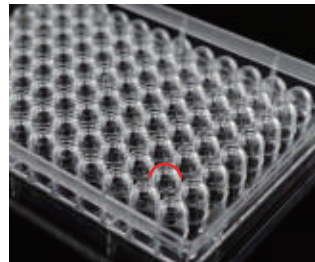
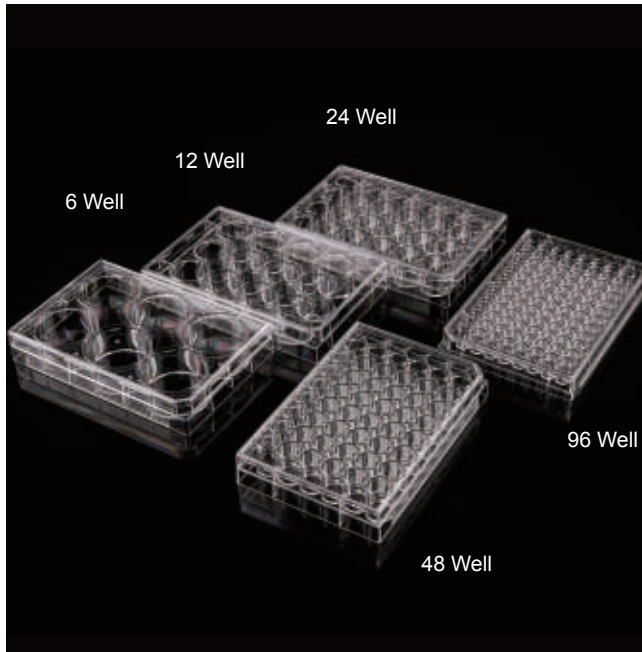

U-bottom plates are suitable for 3D culture.

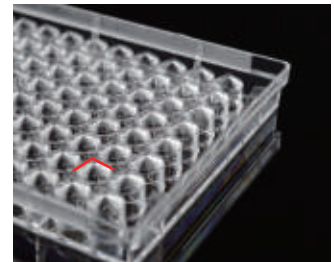

V-bottom plates are suitable for agglutination experiments.

- Sterilized by E-beam, SAL=10⁻⁶.
- High clarity, 100% virgin polystyrene.
- "TC" refers to vacuum plasma tissue culture treatment.
- Clear lot number for batch traceability.
- Markings of well coordinates available for 6, 12, 24, 48 and 384 well plates.
- Non-Pyrogenic, DNase/Rnase free.

*The TC-treated ones are intended for adherent cell culture, while the non-treated ones are suitable for suspension cell culture.

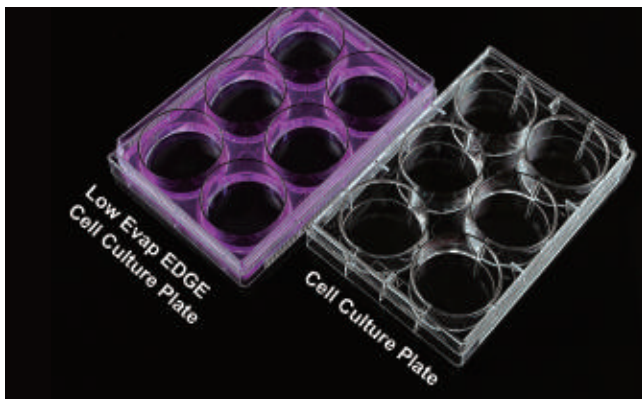

- **Low Evap EDGE Cell Culture Plate**
- Grooves are designed at the edge of the culture plate to avoid the edge effect to the greatest extent and to ensure that the cells maintain their optimal state during cell culture.

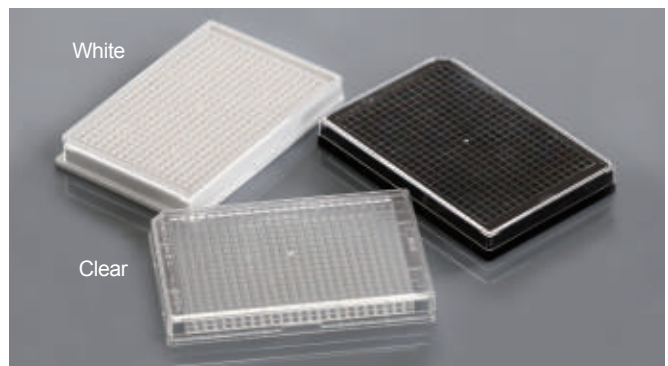

● 384 Well Cell Culture Plate

- NEST microplate have been designed for high content screening (HCS) assays in drug development and related areas. It is also suitable for homogeneous assays employing fluorescence intensity, FRET and TR-FRET where measurements are bottom-read.
- Black microplates, which can reduce mutual influence, are suitable for fluorescent assays involving either top or bottom detection microplate readers.
- White microplates suit luminescent assays involving either top or bottom detection microplate readers.



Individually Packaged



Plastic Bag Package

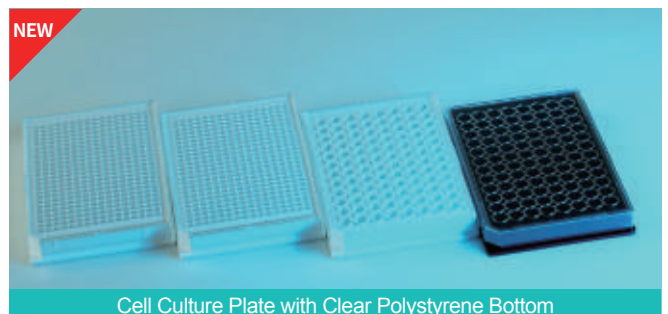

Cell Culture Plate with Clear Polystyrene Bottom

● Cell Culture Plate

Well Number	Cell Growth Area (cm ²)	Recommended Medium Volume (mL)	Bottom Type	Colour	Packing			Cat. No.			
					Packaging	/Pack	/Case	TC Treated	Non-Treated		
6 Well	9.5	1.9-2.9	□	Clear	Individually Packaged	1	50	703001	703011		
					Plastic Bag Package	10	50	703002	703012		
6 Well Low Evap EDGE Plate	3.6	0.76-1.14			Individually Packaged	1	50	714011	714001		
					Plastic Bag Package	10	50	712001	712011		
12 Well	1.9	0.38-0.57			Individually Packaged	1	50	702001	702011		
					Plastic Bag Package	10	50	702002	702012		
24 Well	0.88	0.19-0.285			Individually Packaged	1	50	748001	748011		
					Plastic Bag Package	10	50	748002	748012		
48 Well	0.32	0.1-0.2			□	Clear	Individually Packaged	1	100	701001	701011
					□		Plastic Bag Package	10	100	701002	701012
U	Individually Packaged				1		100	701101	701111		
V	Individually Packaged				1		100	701201	701211		
□	0.32		White	Individually Packaged	1		100	701301	701311		
			Black	Individually Packaged	/		/	/	/		
			White, transparent bottom	Individually Packaged	/	/	/	/			
			Black, transparent bottom	Individually Packaged	/	/	/	/			
96 Well Low Evap EDGE Plate	0.32		0.1-0.2	□	Clear	Individually Packaged	1	100	713011	713001	
				□	Clear	Individually Packaged	1	100	761001	761011	
Plastic Bag Package	10		100			761002	761012				
Black	Individually Packaged		1		100	761301	761311				
White	Individually Packaged	1	100		761601	761611					
White, transparent bottom	Individually Packaged	/	/		/	/					
Black, transparent bottom	Individually Packaged	/	/		/	/					
384 Well	0.11	0.025-0.05	□	Clear	Individually Packaged	1	100	761001	761011		
					Plastic Bag Package	10	100	761002	761012		
					Black	Individually Packaged	1	100	761301	761311	
					White	Individually Packaged	1	100	761601	761611	
					White, transparent bottom	Individually Packaged	/	/	/	/	
					Black, transparent bottom	Individually Packaged	/	/	/	/	

Technical Drawing of Cell Culture Plates

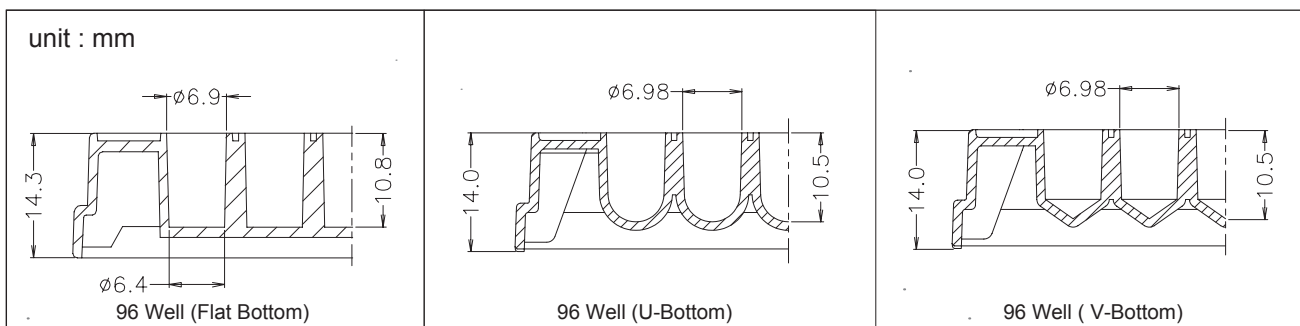
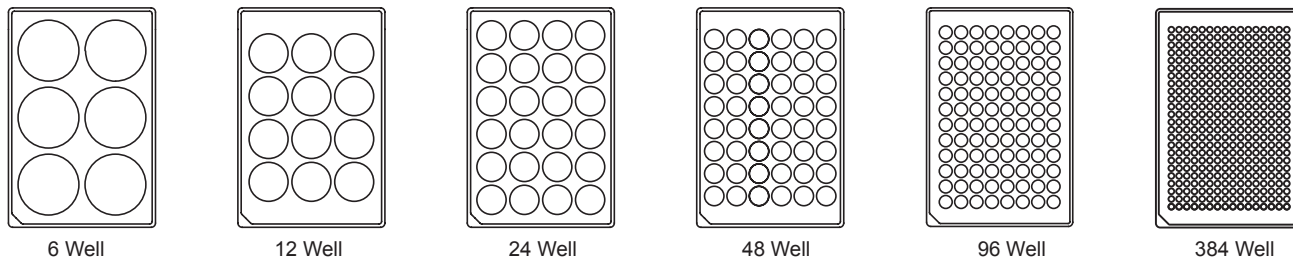

Cell Culture Insert

Cell and tissue culture technologies have an increasing importance in the fields of basic and applied life science. New culture vessels and new surfaces for cell adsorption are continuously emerging, in order to simulate the internal environment as much as possible for culture of some special cell lines. Logically, using permeable supports with a microporous membrane becomes the basic method for culturing these cells. Permeable supports may effectively improve the culture of polar cells, because these supports allow cells to secrete on and absorb molecules from their basal and apical surfaces to metabolize in a more natural way, as well as to stimulate the in vivo environment to the maximum extent for culturing of some special cell lines.

Features

- Sterilized by E-beam, SAL=10⁻⁶.
- Vacuum Plasma tissue culture treatment.
- Non-Pyrogenic, DNase/Rnase free.
- A rich selection of matching plates: 6-well, 12-well, 24-well.
- Passed the USP VI toxicity test.
- Cell culture plates are made of high clarity, 100% virgin polystyrene.
- Clear lot number for batch traceability.
- Innovative edge design for convenient sample loading.
- Low protein binding to ensure accurate results.
- Compatible with most solvents used for fixing and staining.

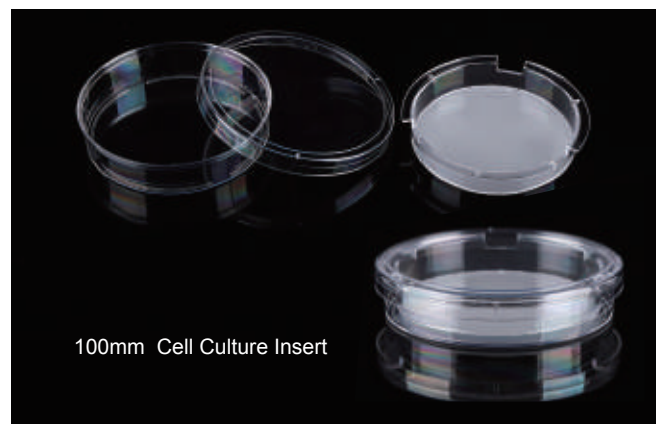
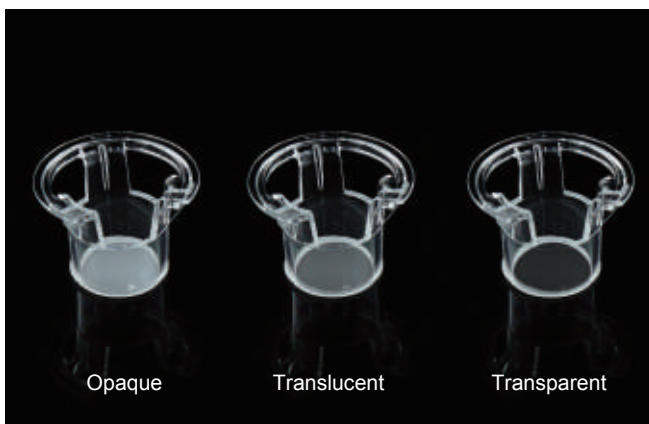
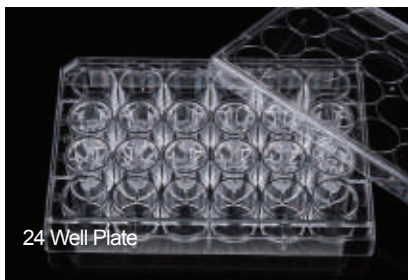
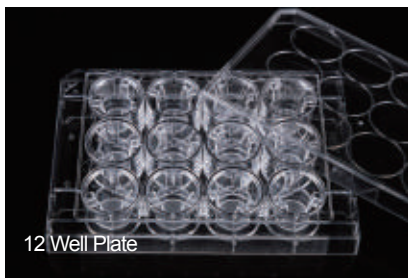
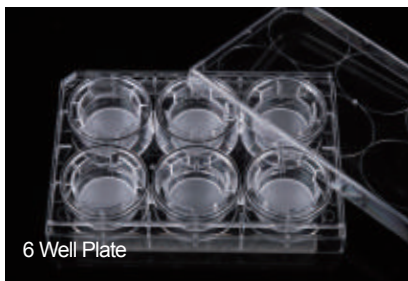

Application Directions and Types

Applications	Cells	Pore size of Membrane
ADME (transport and permeation of compounds through the enterocyte barrier)	Caco-2, MDCK	0.4 μm
Co-culture and cell differentiation, cell imaging	Primary cells, tumor, stem cells	0.4 μm , 1.0 μm
Cell migration and invasion (angiogenesis)	Endothelial cells	3.0 μm
Cyto-chemotaxis (migration) or endothelial migration	Leukocytes	
Axonal hyperplasia	Neurons	
Tumor cell migration and invasion	Tumor-derived cells	8.0 μm
Hematostaxis or migration through endothelial cells	Leukocytes	
Co-culture	Tumor stem cells	
Transport and secretion of macromolecules or viruses		1.0 μm , 3.0 μm

Product Specification



Cell Culture Insert

Specifications	Insert (Pcs/Plate)	Insert Diameter (mm)	Volume of Each Well (mL)	Inner Volume of Insert (mL)	Membrane Growth Area of Insert (cm ²)
6 Well Plate	6	24	2.6	1.5	4.67
12 Well Plate	12	12	1.5	0.5	1.12
24 Well Plate	12	6.5	0.6	0.1	0.33
100mm Dish	1	75	13	9	44

Pore Size of Membrane (μm)	0.4	1.0	3.0	5.0	8.0
Membrane Density (Well/cm ²)	1x10 ⁸	2x10 ⁷	2x10 ⁶	4x10 ⁵	1x10 ⁵
PC Membrane Transparence	Opaque	/	Translucent	Translucent	Translucent
PET Membrane Transparence	Opaque	Transparent	Translucent	/	Transparent

● Cell Culture Insert

Pore Size (μm)	Description	Packing		PC Membrane		PET Membrane	
		/Pack	/Case	TC Treated	Non-Treated	TC Treated	Non-Treated
0.4	6 Cell Culture Inserts + 6 Well Plate	6	60	723101	723111	723121	723131
	12 Cell Culture Inserts + 12 Well Plate	12	120	724101	724111	724121	724131
	12 Cell Culture Inserts + 24 Well Plate	12	120	725101	725111	725121	725131
1	6 Cell Culture Inserts + 6 Well Plate	6	60	/	/	723421	723431
	12 Cell Culture Inserts + 12 Well Plate	12	120	/	/	724421	724431
	12 Cell Culture Inserts + 24 Well Plate	12	120	/	/	725421	725431
3	6 Cell Culture Inserts + 6 Well Plate	6	60	723001	723011	723021	723031
	12 Cell Culture Inserts + 12 Well Plate	12	120	724001	724011	724021	724031
	12 Cell Culture Inserts + 24 Well Plate	12	120	725001	725011	725021	725031
	100 mm Cell Culture Insert-Dish	1	10	726001	/	/	/
5	12 Cell Culture Inserts + 12 Well Plate	12	120	724201	724211	/	/
	12 Cell Culture Inserts + 24 Well Plate	12	120	725201	725211	/	/
8	6 Cell Culture Inserts + 6 Well Plate	6	60	723301	723311	723321	723331
	12 Cell Culture Inserts + 12 Well Plate	12	120	724301	724311	724321	724331
	12 Cell Culture Inserts + 24 Well Plate	12	120	725301	725311	725321	725331

Glass Bottom Cell Culture Dish & Plate

NEST glass bottom series are applied in confocal microscope, high resolution microscope, differential interference contrast microscope, polarized light microscope and phase contrast microscope for cell observation.

Features

- Can be used for live cell observation.
- Special bottom design for easy grip.
- Round cover glass inserts for good appearance.
- Medical adhesive glue to guarantee non-cytotoxicity.
- Sterilized by E-beam, SAL=10⁻⁶.
- Made of high clarity, 100% virgin polystyrene and high clarity glass as bottoms.
- High quality cover glass of standard thickness.

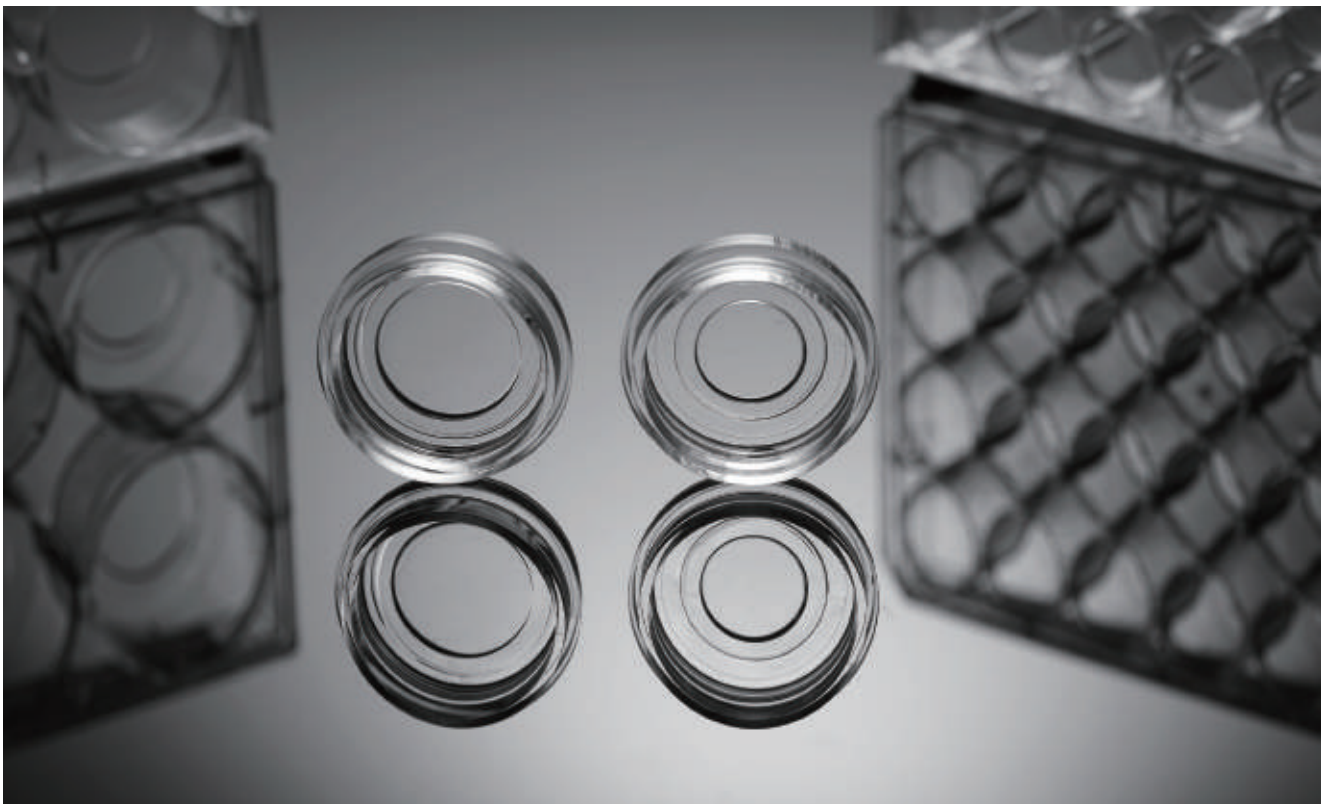
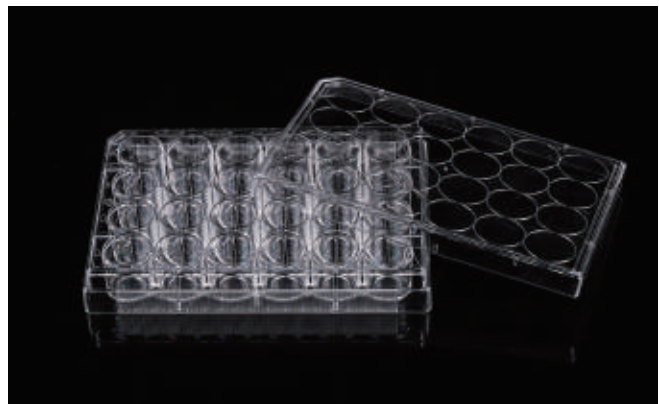
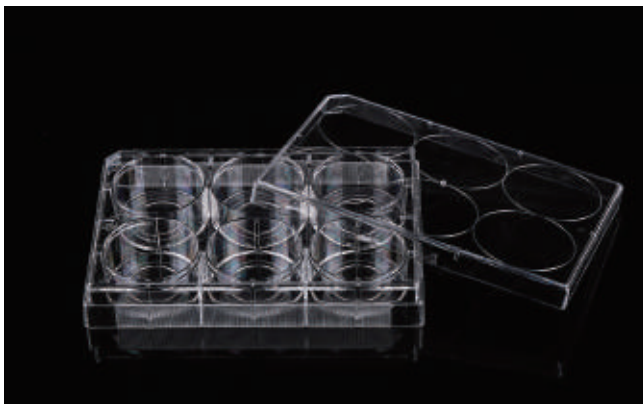

Glass Bottom Culture Dish

Cat.No.	Type (mm)	Glass Diameter (mm)	Cultivation Area (cm ²)	TC	/Pack	/Case
801002	28.2	15	6.2	Yes	10	200
801001	28.2	20	6.2	Yes	10	200

Glass Bottom Culture Plate

Cat.No.	Spec (Well)	Glass Diameter (mm)	Cultivation Area (cm ²)	TC	/Pack	/Case
801004	6	34.8	9.5	Yes	1	10
801006	24	15.6	1.9	Yes	1	10

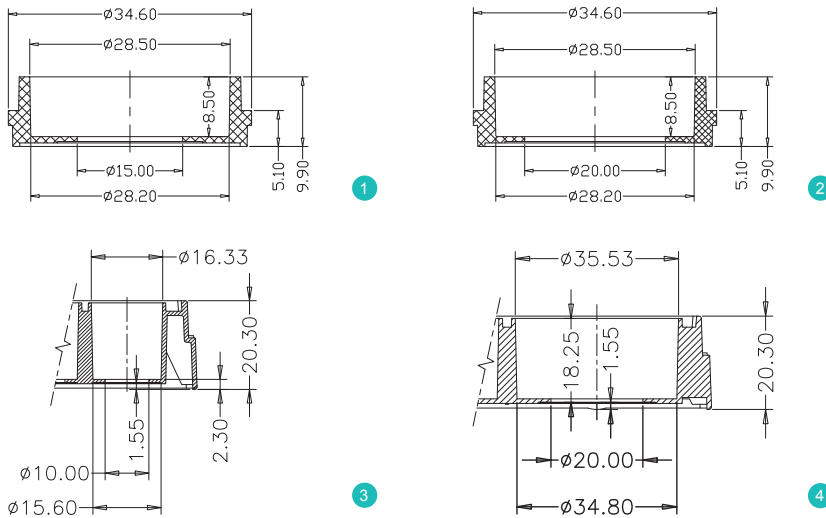

Unit: mm

- ① Ø15 Glass Bottom Dish
- ② Ø20 Glass Bottom Dish
- ③ 24 Well Glass Bottom Plate
- ④ 6 Well Glass Bottom Plate

Cover Glass

Features

- High quality glass, non-cytotoxic.
- Sterile, non-treated.
- Manufactured in class 100,000 clean room.
- Resistant to organic solvent.
- Autoclavable.
- Suitable for used in confocal experiment.



Cat.No.	Glass Diameter (mm)	Thickness (mm)	/Pack	Application
801010	14	0.17	100	24 Well Cell Culture Plate
801007	15	0.17	100	24 Well Cell Culture Plate
801011	18	0.17	100	12 Well Cell Culture Plate
801008	20	0.17	100	12 Well Cell Culture Plate
801009	25	0.17	100	6 Well Cell Culture Plate

Tips:

sterilization: If the glass needs to be sterilized after a long period of non-use, it is recommended to wrap it in tin foil and sterilize it at 180°C in a metal container for two hours.

Coating: Coating can be done with polylysine, collagen, extracellular matrix, and some commercially available reagents containing layer adhesive protein, fibronectin, and proteoglycan, which can improve cell adhesion.

Cell Culture Dish

NEST cell culture dishes are ideal for all types of culturing where microscopic examination is required. Numeric indicators on the bottom of each plate allow users to identify the location of cells.

Features

- High clarity, 100% virgin polystyrene.
- Flat transparent surface for distortion-free observation.
- Vacuum plasma TC treatment, excellent cell adsorption.
- Stackable for easy storage and handling.
- Sterilized by E-beam, SAL=10⁻⁶.
- Non-Pyrogenic, DNase/Rnase free.

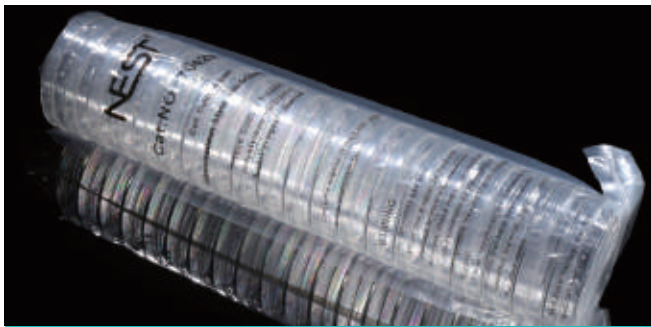
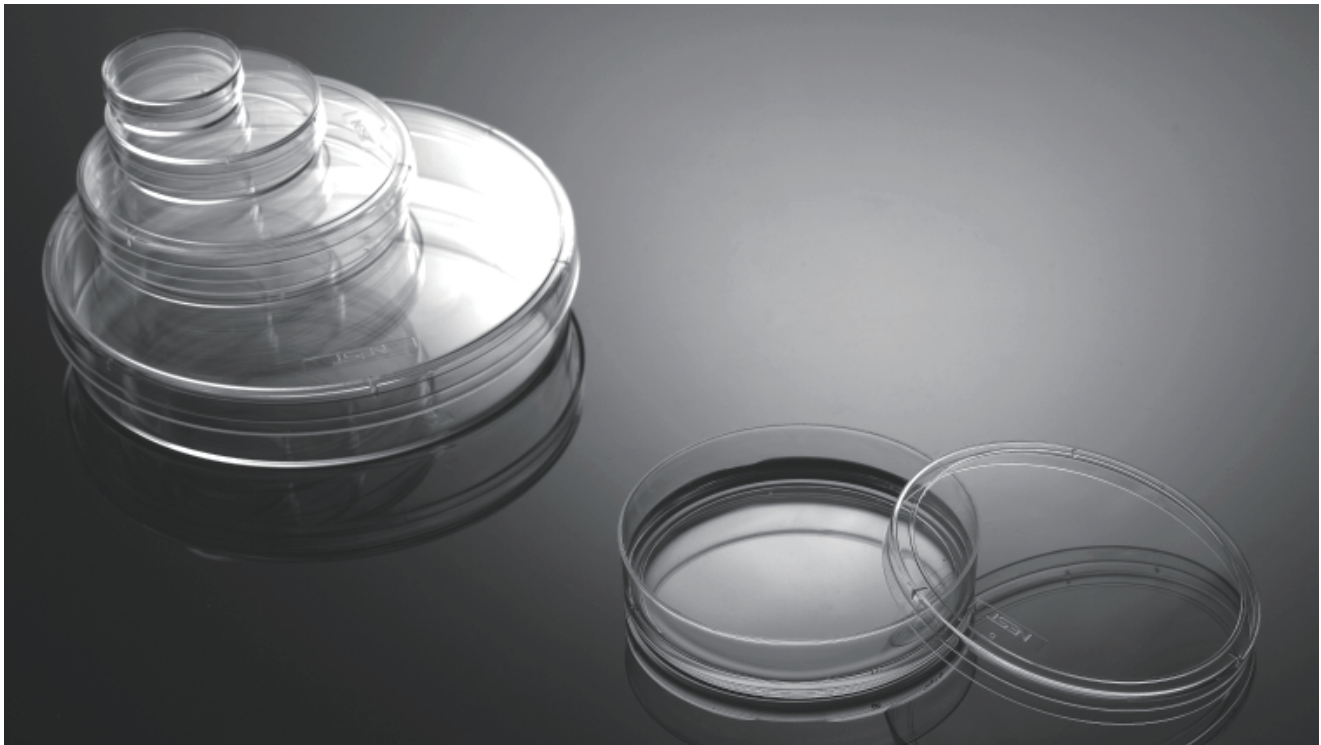

Sterilized Packing

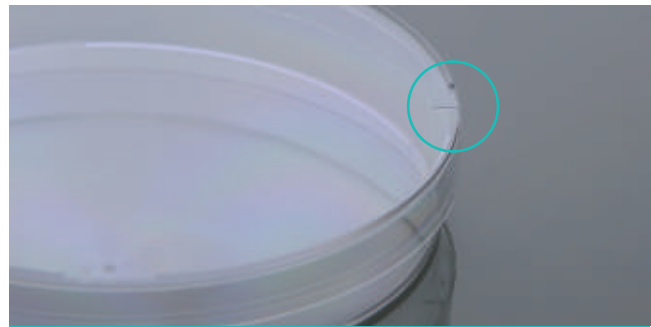

Vent points for Gas Exchange

Feature

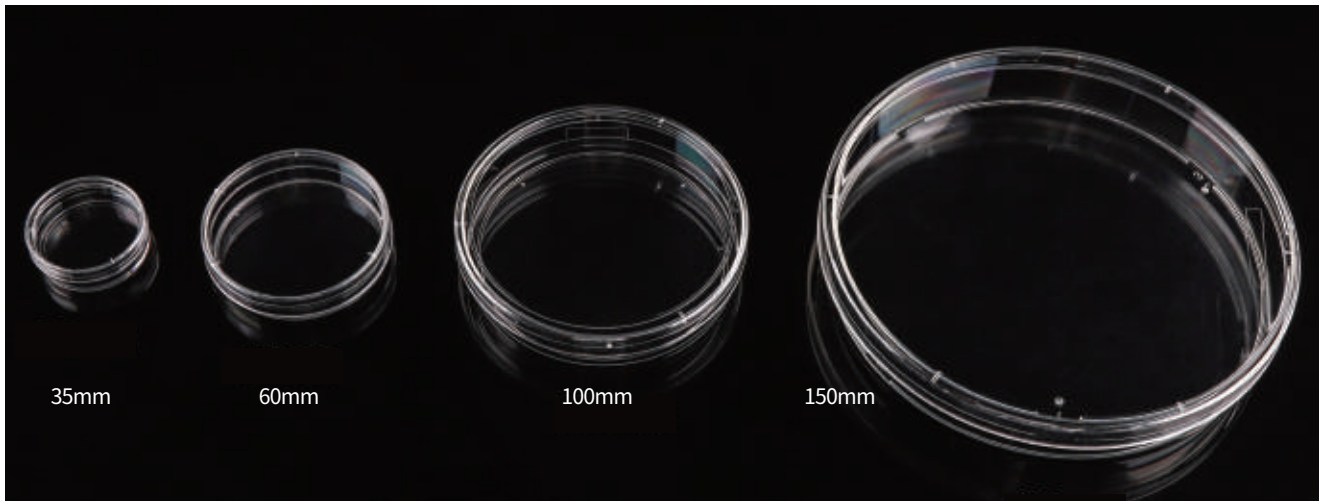

35 mm Dish with Gripping Ring



60 mm Dish with Gripping Ring



100 mm Dish with Gripping Ring

● Cell Culture Dish

Specification (mm)	Height (mm)	Cell Growth Area (cm ²)	Rcommended Medium Volume (mL)	Types	Packing		Cat.No.
					/Pack	/Case	
35	12	8.5	1.8-2.7	Regular	20	25	706001
				Easy Grip	20	25	706201
60	15	22.9	4.2-6.3	Regular	20	25	705001
				Easy Grip	20	25	705201
100	20	57.6	11-16.5	Regular	5	60	704004
					10	30	704002
					20	15	704001
		Easy Grip		10	30	704202	
				20	15	704201	
				5	20	715001	

Actual diameter is smaller than the indicated
 35 mm dish bottom inner diameter: 35.0 mm
 60 mm dish bottom inner diameter: 54.0 mm
 100 mm dish bottom inner diameter: 85.6 mm
 150 mm dish bottom inner diameter: 138.2 mm
 100 mm easy grip dish bottom inner diameter: 86.9 mm

Cell Culture Flask

NEST's Cell Culture Flasks whose cell growth areas ranging from 25cm² to 225cm² are available. These flasks are available as issue culture treated or non-treated as well as with a vent cap or plug seal cap to meet your requirements.

Features

- Made of high clarity, 100% virgin polystyrene.
- Sterilized by E-beam, SAL=10⁻⁶.
- Non-Pyrogenic, DNase/Rnase free.
- Frosted writing and clear graduations.
- Notched bottom for slip free slip stacking.
- Clear lot number for batch traceability.
- Packaged in sterile, zip-sealable bags.

• 3 / 5 - Layer Cell Culture Flask

- Made of high clarity, 100% virgin polystyrene.
- Sterilized by E-beam, SAL=10⁻⁶.
- Non-Pyrogenic, DNase/Rnase free.
- 3-Layer Cell Culture Flask Growth area: 520 cm².
- 5-Layer Cell Culture Flask Growth area: 870 cm².
- Individually packaged in sterile bag.

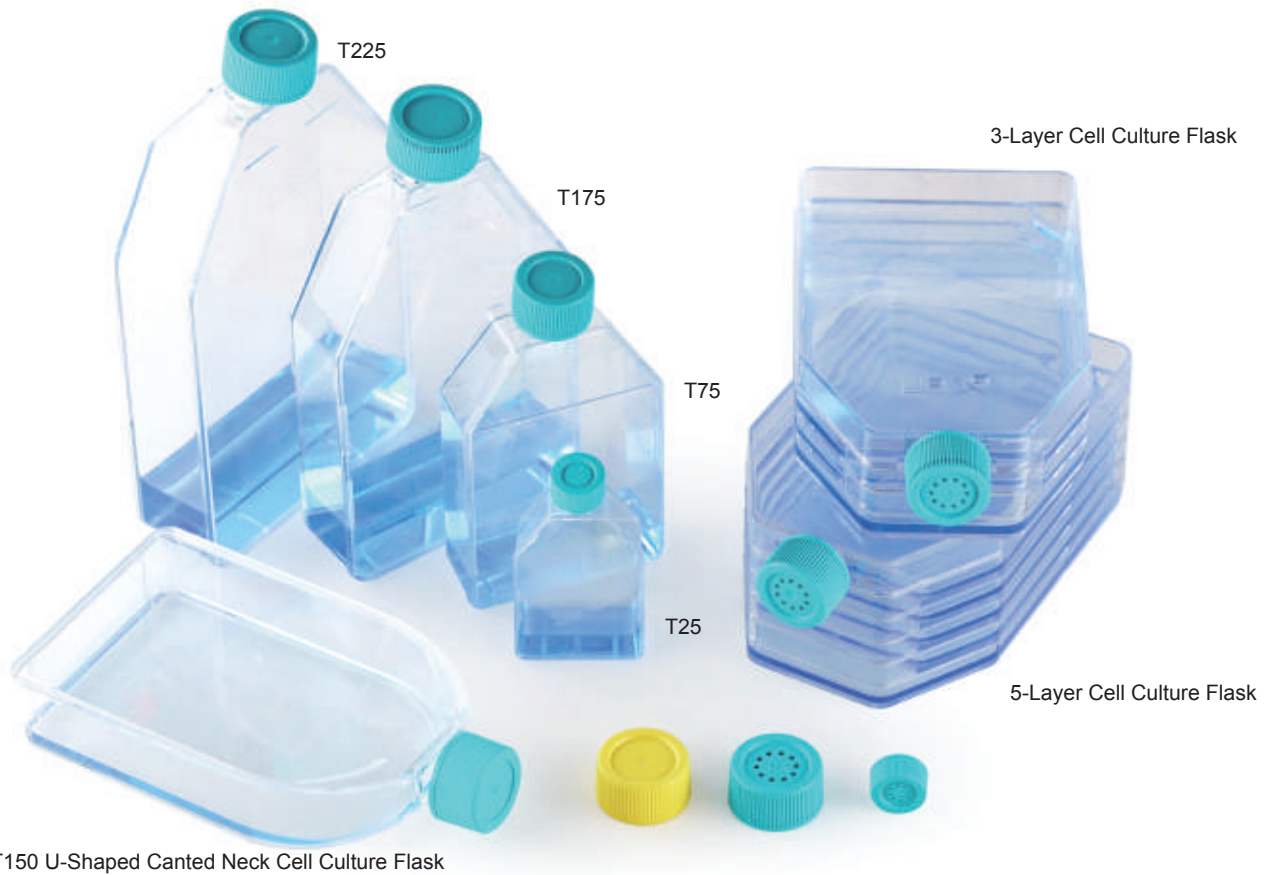

Yellow caps for non-treated flask



Vent caps and plug seal caps

Vent caps with 0.22 μm hydrophobic filters to ensure gas exchange without contamination

Feature

User guide for seeding cells into a 5-layer Cell Culture Flask

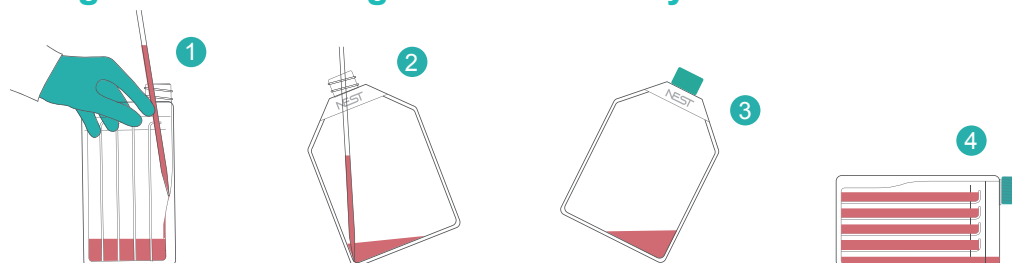

1. Prepare cell suspension of the required concentration, then mix it with medium evenly in a container. A volume of 30-50 mL per layer is recommended.
2. Slowly add the mixed solution into the 5-layer Cell Culture Flask with a serological pipette. To avoid foam or bubbles, it is recommended to set the pipette firmly against the wall, enable the stream to flow along the slope, and save a little liquid in the pipette each time.
Notes: While a 10 ml pipette can disperse the medium at the bottom, a 25 ml pipette will only reach up to the NEST mark to disperse the medium.
3. Position the Multi-layer Flask upright with the NEST mark facing you, tilt it 45° clockwise and let stand in this position for a while to level the liquid in each layer.
4. Gently lay it flat onto the workbench with NEST mark facing upwards.
5. Gently shake it from side to side to distribute cells evenly onto culture surfaces.
Notes: be careful to shake gently to avoid foam or bubbles and spilling liquid from each layer.
6. Transfer the flask to the incubator for incubation

Culture medium removal

1. Aspiration

Tilt the flask 45° clockwise with the NEST mark facing you. counter-clock wise to a 45° angle while inverting the Multi-Flask toward you. Then reach the serological pipette into the bottom for fully aspiration.

2. Pouring

Tilt the flask 45° counterclockwise with the NEST mark facing you, pour the spent media from the flask.

Tips: A NEST 10mL serological pipette is suggested for fully aspiration.

Cell harvesting

1. Rinse off the residual serum with buffer, add digestion solution (≥ 5 mL per layer) and mix evenly. Then, follow Steps 3-4 to distribute to dissociating reagent to each layer.
2. Let stand for 2 min, then neutralize and mix with inactivating solution following steps 3-4. Gently swirl to dislodge cells completely.
3. Transfer the solution in a centrifuge tube or other containers by aspiration or pouring.
4. Rinse the flask with buffer for three times, then transfer the buffer into the centrifuge tube for passage and counting.

Tips: Search "NEST Multi-layer Flask" video on YouTube(@nest-wuxi4075).

Cell Culture Flask

Cell Growth Area (cm ²)	Maximum Graduated Volume (mL)	Recommended Medium Volume (mL)	Size(mm)			Packing		TC Treated		Non-Treated	
			Base Height	Width	Length	/Pack	/Case	Plug seal caps	Vent caps	Plug seal caps	Vent caps
25	30	5-7.5	25.9	53.8	97.13	10	20	707001	707003	707011	707013
75	225	15-22.5	35.7	89.56	160.01	5	20	708001	708003	708011	708013
150	375	30-45	40.3	110.75	203	5	8	720001	720003	720011	720013
175	400	35-52.5	39.1	120.51	217.9	5	8	709001	709003	709011	709013
225	700	45-67.5	46.05	137	238.5	5	5	721001	721003	721011	721013
520 (3-layer)	50	60-100	60.1	120.5	203	1	12	731301	731302	/	/
870 (5-Layer)	50	100-150	84.3	120.5	203.6	1	8	731001	731002	/	/

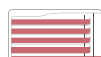

Precautions:

It is important to handle multi-layer Cell Culture Flasks with caution to avoid the formation of bubbles. The presence of bubbles can lead to the creation of siphon bridge at the baffle, resulting in the upper layer of culture medium flowing down to the bottom.

Cell Scraper

Features

- Free rotating blade, makes the blade twist to the right direction.
- Two sizes are available.
- Easy-tear sterile packing.
- Sterilized by E-beam, SAL=10⁻⁶.
- Non-Pyrogenic, DNase/Rnase free.
- Individually packaged.

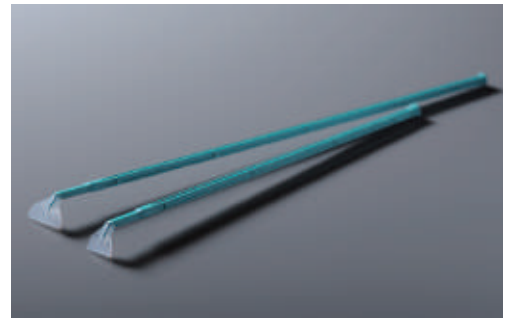

Spec(mm)		Colour	Sterile	/Case	Cat.No.
Total Length	Blade Width				
220	13	Blue handle + transparent blade	Yes	100	710001
280	20	Blue handle + transparent blade	Yes	100	710011

Cell Strainer



Features

- Ideal for stem cell and tissue-derived primary cell preparation.
- Fits nearly all 50ml conical tubes.
- Tab molded within upper ring enables easy sterile handling.
- Sterilized by Gamma ray.
- Non-Pyrogenic, DNase/Rnase free.
- Individually packaged.

Spec (µm)	目数	Color	/Pack	/Case	Cat.No.
40	360	Blue	1	50	258366
70	220	White	1	50	258365
100	150	Yellow	1	50	258364

50mL Min Bioreactor

Features

- USP VI Polypropylene.
- High transparency, easy to observe.
- Vent caps with 0.22 µm hydrophobic filters for gas exchange without contamination.
- Packaged in sterile, zip-sealable bags.
- Sterilized by E-beam, SAL=10⁻⁶.
- Non-Pyrogenic, DNase/Rnase free.
- Suitable for used for centrifugation.

Volume (mL)	/Pack	/Case	Cat.No.
50 mL Vent caps Sterile	10	10	788211





Bioprocessing Solutions

OptiFlask® Erlenmeyer Flask

NEST Erlenmeyer Flask collection is designed for suspension cell culture, and is ideal for small-scale research and industrial production of vaccines, proteins, monoclonal antibodies and biopharmaceuticals.

NEST provides Erlenmeyer Flasks in sizes ranging from 125 to 3000mL, as well as High Efficiency Erlenmeyer Flasks in sizes of 2-5L. Each size option comes with a choice of a seal or vent cap, as well as the option of a flat bottom or a bottom with baffles. The Erlenmeyer Flasks are available in both PC and PETG.

Accordingly, NEST offers customized transfer caps that are compatible with our Erlenmeyer Flask collection. These caps come in various sizes and can also be tailored to accommodate diverse requirements, allowing for liquid transfer and cultivation in a closed environment.

Strict product quality supervision

Production environment--Class 10,000 clean production workshop

NEST Factory™ is produced in a dedicated 10,000-class clean room, and other products are produced in a 100,000-class clean room.

Production material--Strictly selected polystyrene conforming to USP Class VI standard

Quality Assurance from Professional Testing Agencies

NEST ensures top product quality, stability, safety, applicability, and effectiveness through the implementation of state-of-the-art production technology and a strict quality control system. All our product ranges have undergone rigorous validation by professional testing institutions possessing national testing qualifications (CMA, CNAS). The internationally recognized testing results provide further assurance.

Performance Testing

Relevant performance testings include sealing test, pressure resistance test, inter-batch stability, endotoxin, nucleic acid enzyme, and cell culture comparative experiments.

Sample batch	Culture time(h)	72	76	120	144	168	192
060622AP02	Cell count	3.82×10^6	5.78×10^6	6.46×10^6	6.79×10^6	7.48×10^6	5.59×10^6
	Amplification factor	12.72	19.25	21.53	22.63	24.94	18.62
061122AP01	Cell count	3.69×10^6	5.67×10^6	6.66×10^6	7.09×10^6	7.05×10^6	5.95×10^6
	Amplification factor	12.30	18.91	22.19	23.62	23.51	19.83
081822AP01	Cell count	3.72×10^6	5.60×10^6	6.58×10^6	7.13×10^6	7.32×10^6	5.88×10^6
	Amplification factor	12.40	18.66	21.93	23.78	24.40	19.59

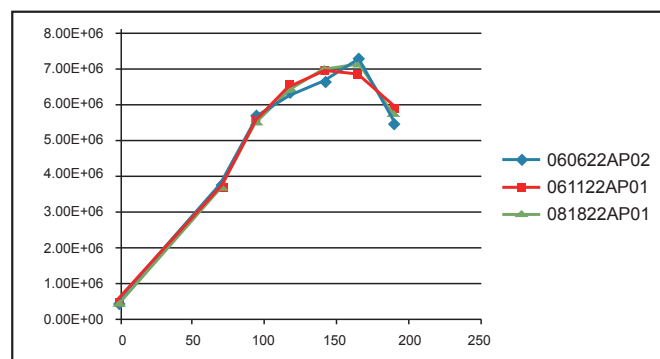
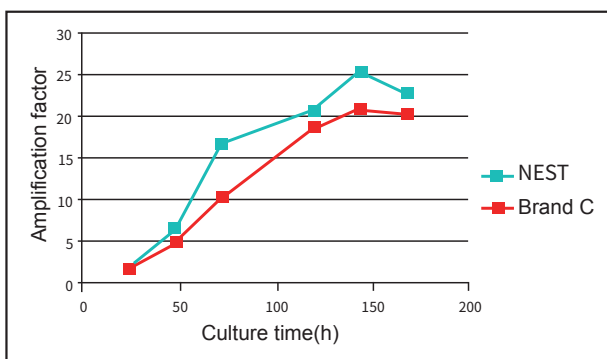

Biosafety testing

Refer to <<State Food and Drug Administration National Standards for Packaging Materials and Containers in Direct Contact with Drugs (Series 6)>>, The product is tested for cytotoxicity, sensitization, intradermal irritation, acute systemic toxicity and hemolysis.

Physical and chemical safety testing

Refer to <<State Food and Drug Administration National Standards for Packaging Materials and Containers in Direct Contact with Drugs (Series 6)>>, The products are tested for insoluble particles, ignition residues, metal elements, and dissolved substances (clarity, color, pH, UV absorbance, non-volatile matter, easy oxides, heavy metals).

Testing item	Detection limit (mg/L)	Test result (mg/L)
Lead	0.05	N.D.
Tin	0.04	N.D.
Cadmium	0.02	N.D.
Chromium	0.03	N.D.

Testing item	Requirement or detection limit	Testing result
Reducing substances (consumption of $c(1/5KMnO_4)=0.01mol/L$)	≤ 0.5 mL	0.12
Acid-base pH (compared with blank solution)	< 1	0.22
Evaporated residue, mg/50mL	< 2.5 mg	0.9
UV absorbance 230nm~360nm	< 0.05	0.0070
Appearance	Colorless and transparent	Colorless and transparent
Lead content , $\mu g/mL$	< 0.05	Below the detection limit
Tin content, $\mu g/mL$	< 0.04	Below the detection limit
Cadmium content, $\mu g/mL$	< 0.02	Below the detection limit
Chromium content, $\mu g/mL$	< 0.03	Below the detection limit

Sterility and particle guarantee

NEST ensures thorough testing of its products through examinations of the irradiation process, packaging, and insoluble particles. The verification of the irradiation dose distribution is conducted in accordance with ISO 11137-1:2015, meeting the necessary requirements for sterilization irradiation dose ($SAL=10^{-6}$).

OptiFlask® Erlenmeyer Flask



Erlenmeyer Flask, Flat-bottom



Erlenmeyer Flask, Baffled

- Erlenmeyer Flask collection is suitable for suspension cell culture or bacterial culture, and can also be used for medium preparation, mixing, and storage.
- The body is made of PETG/PC, and the cap is made of PP. Both materials comply with USP Class VI.
- Qualified by the USP Class 6 Standard, PC bottle with high transparency, is resistant to strong impact, oxidation and high temperature up to 121 °C.
- Vent caps with 0.22 µm hydrophobic filters for gas exchange without contamination.
- The baffled bottom can improve gas exchange efficiency and ensure better oxygen dissolution in the culture medium, but it also increases cell shear force.

Feature

- Individually packaged in sterile bags
- There's a scale made by injection molding on the flask body to facilitate observing the filled liquid volume.
- Non-Pyrogenic, DNase/Rnase free.
- Sterilized by E-beam, SAL=10⁻⁶.

● Erlenmeyer Flask

Volume (mL)	Size(mm)			Cap Style	Packing		PETG Erlenmeyer Flask		PC Erlenmeyer Flask	
	Height	Bottleneck Diameter	Bottom Diameter		/Pack	/Case	Flat-bottom	Baffled	Flat-bottom	Baffled
125	106.8	34	66	Seal Cap	1	24	781001	781301	781101	781201
				Vent Filter Cap	1	24	781011	781311	781111	781211
250	137.8	34	83	Seal Cap	1	12	782001	782301	782101	782201
				Vent Filter Cap	1	12	782011	782311	782111	782211
500	175.8	39	101	Seal Cap	1	12	783001	783301	783101	783201
				Vent Filter Cap	1	12	783011	783311	783111	783211
1000	213.3	39	127	Seal Cap	1	6	784001	784301	784101	784201
				Vent Filter Cap	1	6	784011	784311	784111	784211
2000	285	47	162	Seal Cap	1	6	/	/	785001	/
				Vent Filter Cap	1	6	/	/	785011	/
3000	253	62	230	Seal Cap	1	4	/	/	786001	/
				Vent Filter Cap	1	4	/	/	786011	/

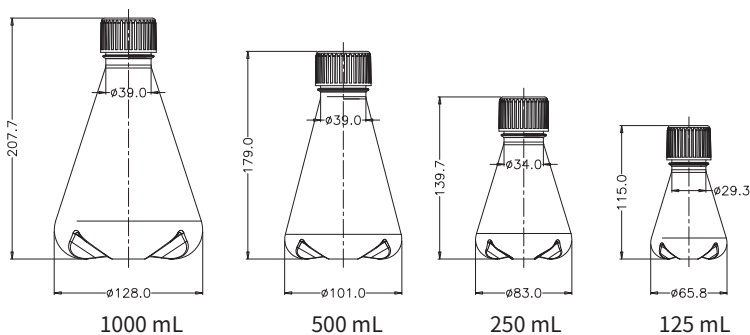
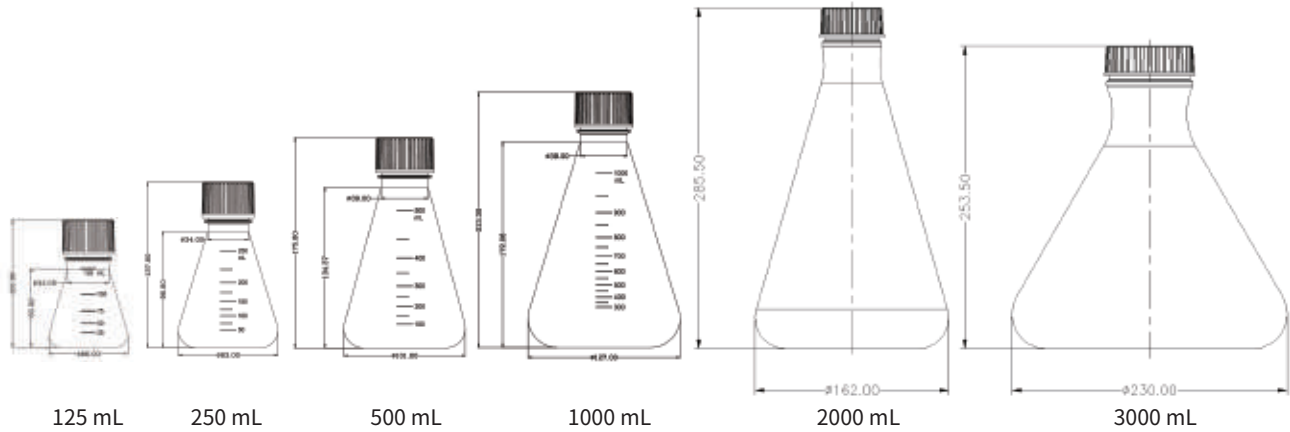

OptiFlask® Erlenmeyer Flask, High Efficiency



High-efficiency, large-volume culture flasks allow cells to show strong viability with large expression amount of proteins in the culture of mammalian cells and insect cells. During the culturing process, the use rate of the shaker is significantly increased, and the survival rate and viability of cells are both dramatically elevated. NEST culture flasks also provide high repeatability, which allows highly inter-batch consistency of cell growth and yield.

Feature

- Qualified by the USP Class 6 Standard, PC bottle with high transparency, is resistant to strong impact, oxidation and high temperature up to 121 C.
- Obvious and accurate scale.
- The vent cap is covered with a 0.2 µm vent membrane, watertight but not airtight.
- Equipped with transfer Cap, more safe and convenient operation.
- Individually packaged in sterile bag.
- Non-Pyrogenic, DNase/Rnase free.
- Suitable for suspension cell culture or bacterial culture, as well as for medium preparation, mixing, and storage
- Sterilized by E-beam, SAL=10⁻⁶.

● Erlenmeyer Flask, High Efficiency

Volume (L)	Dimension (mm)			Cap Style	/Case	Cat.No.	
	Height	Bottleneck Dia	Bottom Dia			Flat-bottom	With Baffles
2.0	213.5	67	162	Seal Cap	4	785101	785105
	213.5	67	162	Vent Filter Cap	4	785111	785115
3.0	253.5	67	162	Seal Cap	4	786101	786105
	253.5	67	162	Vent Filter Cap	4	786111	786115
3.0 (Wide-mouth)	253.5	90	162	Seal Cap	4	786501	786505
	253.5	90	162	Vent Filter Cap	4	786511	786515
5.0	253.5	90	230	Seal Cap	4	787001	787005
	253.5	90	230	Vent Filter Cap	4	787011	787015

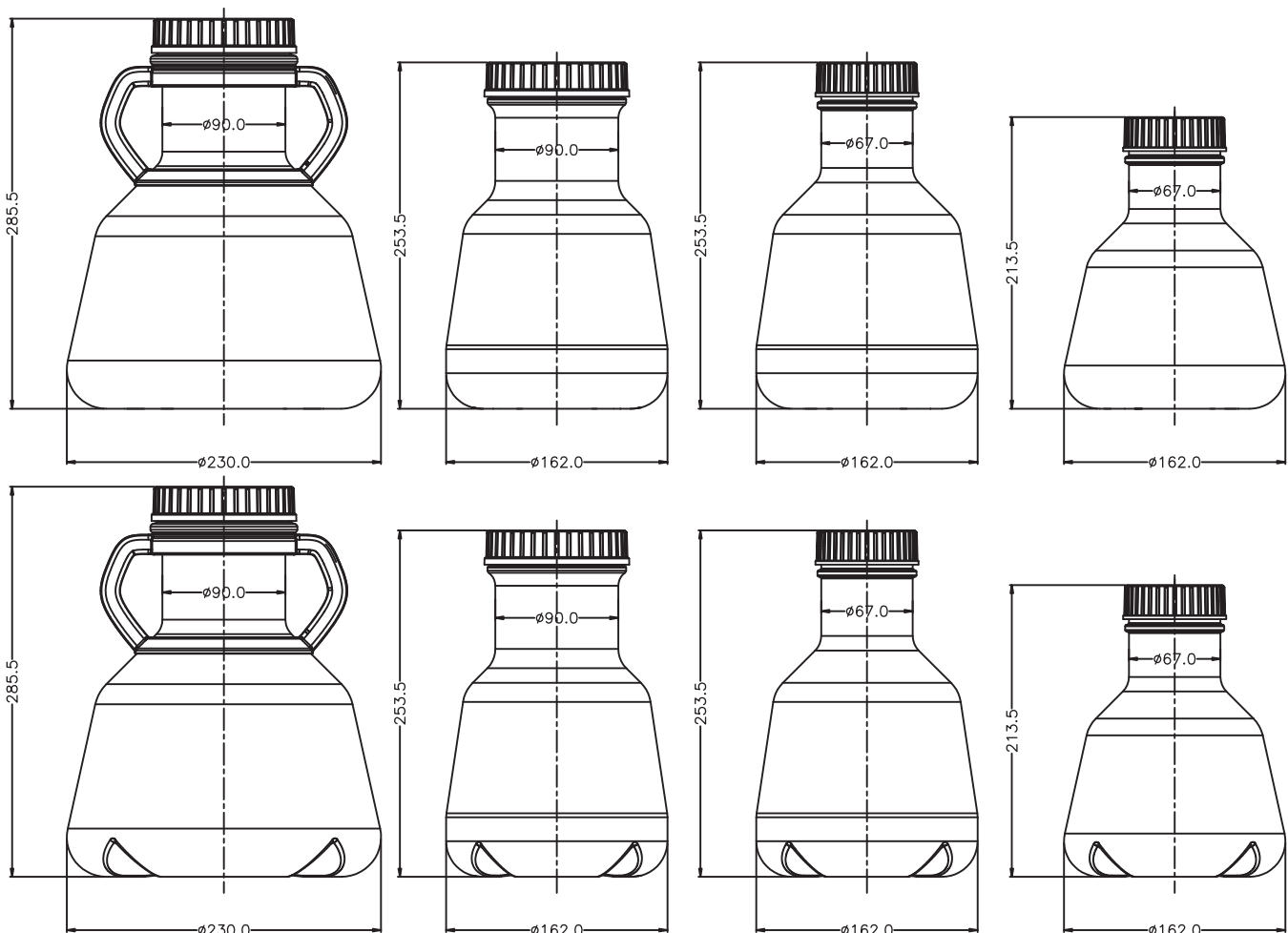

Accessories

- Closed system reduces the risks of contamination during liquid transfer.
- One-piece construction of caps and connectors reduces the risk of leakage and media residue.
- Caps of various diameters are available and aseptic welding of liquid inlet tubing under normal conditions is supported.
- High-quality materials and smooth inner wall of the tubing provide an excellent transfer performance.
- Sterilized by E-beam, SAL=10⁻⁶.
- Endotoxin-free, and no ingredients of animal origin.
- Individually packaged in sterile bag.



● Bi-directional Liquid Transfer Cap System

- For aseptic transfer of culture medium and cell culture solution.
- One end of the pipeline is connected to the MPC series connector, which increases the convenience and safety in use. The male connector and the sealing cap are tightly connected to prevent accidental disconnection, and the connector can be rotated to reduce pipeline distortion.



● Multifunction Liquid Transfer Cap

Compatible with 2/3/5L high efficient Erlenmeyer flasks. Different from bi-directional liquid transfer cap, the multifunctional transfer cap can be directly placed in an incubator for culture after the liquid transfer is completed. It can reach a large air flux. The quick sampling connector is composed of a sampling nozzle and a one-way valve, which can prevent the liquid from flowing backwards during the sampling process and ensure the aseptic sampling. The liquid inlet tubing is provided with a PTFE needle filter, which solves the issue of liquid remaining in the tubing during the feeding process.



● Inverted Liquid Transfer Caps

- No need for other equipment, and no damage to cells.
- Invert the bottle to transfer the liquid by gravity.
- Available with regular tubing or wide-mouth tubing.

Erlenmeyer Flask Closed System Solution

To customize a Erlenmeyer Flask Closed System Solution that meets your needs, follow these steps:

Step 1

- Choose the bottle capacity
- Choose the bottle material



Bottle Material (PETG PET PC)

Notes: you may order the transfer cap only

Generate custom graphics by submitting your request on www.cell-nest.com



Step 2

- Choose the cap type

Notes: Compatible with diverse connectors

Step 3

- Choose the tube size/length
- Choose the tube material

Inlet and outlet liquid tubing (Vulcanized silicone tube P welded tube)

Step 4

- Choose the membrane area Air filter (PVDF membrane)



Membrane (4.5cm² 13.8cm² 20cm² Other)

Step 5

- Choose the connector type
- ① Luer connector (male and female)
 - ② MPC connector (male and female)
 - ③ Heat sealing (no connector)

MPC Connector (male/female) Luer Connector (male/female) Heat Seal (no connector)

= Results



Inform our sales or product engineer of your choice if you have completed your selection.

● High Efficient Erlenmeyer Flask Closed System

Volume (mL)	Transfer Caps for High Efficient Erlenmeyer Flasks							Closed System	
	Cap Style	Tube Material				0.2µm Filter Membrane area	Cat.No.	Cat.No.	
		External Liquid Transfer Tube			Connector			Flat-bottom	With Baffles
		材质	Length (cm)	Dia.					
125 mL	Bi-directional Liquid Transfer	Silicon Tube	50	1/8" ID, 1/4" OD	MPC Male Connector	Φ42mm	C30821-EAC050B		
250 mL					Male Luer Connector		C30821-EFC050B		
					MPC Male Connector		C30921-EAC050B		
500 mL					Male Luer Connector		C30921-EFC050B		
					MPC Male Connector		C31021-EAC050B		
1000 mL					Male Luer Connector		C31021-EFC050B		
					MPC Male Connector		C31121-EAC050B		
					Male Luer Connector		C31121-EFC050B		
2L High Efficiency	Multifunction Liquid Transfer	TPE Tube	52	1/8" ID, 1/4" OD	Heat Seal (Supports sampling)	Φ50mm	C10111-AJE052B		
		TPE Tube	50	1/4" ID, 7/16" OD	Heat Seal	Φ24mm	C10111-DZB050B		
		Silicon Tube	100	3/16" ID, 3/8" OD	MPC Male Connector	Φ24mm	C10111-GBB100B		
	Bi-directional Liquid Transfer	TPE Tube	50	1/8" ID, 1/4"OD	Heat Seal	Φ24mm	C10122-AZB050B	C10122-AZB050A	C20122-AZB050A
		TPE Tube	50	1/4" ID, 3/8" OD	Heat Seal	Φ42mm	C10123-BZC050B	C10123-BZC050A	
		Silicon Tube	50	1/4" ID, 3/8" OD	MPC Male Connector	Φ42mm	C10123-FBC050B		
		Silicon Tube	50	1/4" ID, 3/8" OD	MPC Female Connector	Φ42mm	C10123-FDC050B		
	Inverted Liquid Transfer	TPE Tube	50	1/8" ID, 1/4" OD	Heat Seal	Φ42mm	C10131-AZC050B		
		TPE Tube	50	1/4" ID, 7/16" OD	Heat Seal	Φ42mm	C10133-DZC050B		
	3L High Efficiency	Multifunction Liquid Transfer	TPE Tube	52	1/8" ID, 1/4" OD	Heat Seal (Supports sampling)	Φ50mm	C10211-AJE052B	
TPE Tube			50	1/4" ID, 7/16" OD	Heat Seal	Φ24mm	C10211-DZB050B		
Silicon Tube			100	3/16" ID, 3/8" OD	MPC Male Connector	Φ24mm	C10211-GBB100B		
Bi-directional Liquid Transfer		TPE Tube	50	1/8" ID, 1/4"OD	Heat Seal	Φ24mm	C10222-AZB050B	C10222-AZB050A	C20222-AZB050A
		TPE Tube	50	1/4" ID, 3/8" OD	Heat Seal	Φ42mm	C10223-BZC050B	C10223-BZC050A	
		Silicon Tube	50	1/4" ID, 3/8" OD	MPC Male Connector	Φ42mm	C10223-FBC050B		
		Silicon Tube	50	1/4" ID, 3/8" OD	MPC Female Connector	Φ42mm	C10223-FDC050B		
Inverted Liquid Transfer		TPE Tube	50	1/8" ID, 1/4" OD	Heat Seal	Φ42mm	C10231-AZC050B		
		TPE Tube	50	1/4" ID, 7/16" OD	Heat Seal	Φ42mm	C10233-DZC050B		
3L Wide-mouth High Efficiency		Multifunction Liquid Transfer	TPE Tube	52	1/8" ID, 1/4" OD	Heat Seal (Supports sampling)	Φ50mm	C10311-AJE052B	
	TPE Tube		50	1/4" ID, 7/16" OD	Heat Seal	Φ24mm	C10311-DZB050B		
	Silicon Tube		100	3/16" ID, 3/8" OD	MPC Male Connector	Φ24mm	C10311-GBB100B		
	Bi-directional Liquid Transfer	TPE Tube	50	1/8" ID, 1/4"OD	Heat Seal	Φ24mm	C10322-AZB050B	C10322-AZB050A	C20322-AZB050A
		TPE Tube	50	1/4" ID, 3/8" OD	Heat Seal	Φ42mm	C10323-BZC050B	C10323-BZC050A	
		Silicon Tube	50	1/4" ID, 3/8" OD	MPC Male Connector	Φ42mm	C10323-FBC050B		
		Silicon Tube	50	1/4" ID, 3/8" OD	MPC Female Connector	Φ42mm	C10323-FDC050B		
	Inverted Liquid Transfer	TPE Tube	50	1/8" ID, 1/4" OD	Heat Seal	Φ42mm	C10331-AZC050B		
		TPE Tube	50	1/4" ID, 7/16" OD	Heat Seal	Φ42mm	C10333-DZC050B		
	5L High Efficient	Multifunction Liquid Transfer	TPE Tube	30	1/8" ID, 1/4" OD	Heat Seal	No Filter	/	C10442-AKA060A
TPE Tube			92	1/8" ID, 1/4" OD	Heat Seal (Supports sampling)	Φ50mm	C10411-AJE092B		
TPE Tube			90	1/4" ID, 7/16" OD	Heat Seal	Φ24mm	C10411-DZB090B		
Silicon Tube			100	3/16" ID, 3/8" OD	MPC Male Connector	Φ24mm	C10411-GBB100B		
Bi-directional Liquid Transfer		TPE Tube	90	1/8" ID, 1/4"OD	Heat Seal	Φ24mm	C10422-AZB090B	C10422-AZB090A	
		TPE Tube	90	1/4" ID, 3/8" OD	Heat Seal	Φ42mm	C10423-BZC090B	C10423-BZC090A	
		Silicon Tube	90	1/4" ID, 3/8" OD	MPC Male Connector	Φ42mm	C10423-FBC090B		
		Silicon Tube	90	1/4" ID, 3/8" OD	MPC Female Connector	Φ42mm	C10423-FDC090B		
Inverted Liquid Transfer		TPE Tube	90	1/8" ID, 1/4" OD	Heat Seal	Φ42mm	C10431-AZC090B		
		TPE Tube	90	1/4" ID, 7/16" OD	Heat Seal	Φ42mm	C10433-DZC090B		

Accessories

Erlenmeyer Flasks Accessories

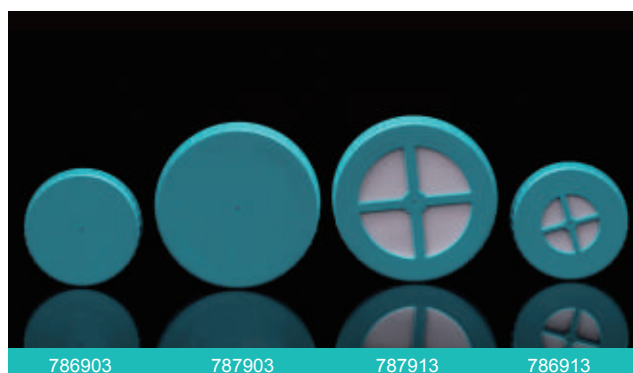

Compatibility	/Pack	/Case	Cat.No.
Seal Cap for 125 mL PC Erlenmeyer Flasks	1	25	781905
Vent Cap for 125 mL PC Erlenmeyer Flasks	1	25	781915
Seal Cap for 250 mL PC Erlenmeyer Flasks	1	25	781925
Vent Cap for 250 mL PC Erlenmeyer Flasks	1	25	781935
Seal Cap for 500&1000 mL PC Erlenmeyer Flasks	1	25	782925
Vent Cap for 500&1000 mL PC Erlenmeyer Flasks	1	25	782935
Seal Cap for 2L Erlenmeyer Flasks	1	25	783905
Vent Cap for 2L Erlenmeyer Flasks	1	25	783915
Seal Cap for 3L Conical Erlenmeyer Flasks/2&3L High Efficient Erlenmeyer Flasks	1	25	783925
Vent Cap for 3L Conical Erlenmeyer Flasks/2&3L High Efficient Erlenmeyer Flasks	1	25	783935
Seal Cap for 3L Wide-mouth/5L Erlenmeyer Flasks	1	20	785903
Vent Cap for 3L Wide-mouth/5L Erlenmeyer Flasks	1	20	785913

BioFactory

Strict product quality supervision

Production environment--Class 10,000 clean production workshop

NEST Factory is produced in a dedicated 10,000-class clean room, and other products are produced in a 100,000-class clean room.

Production material--Strictly selected polystyrene conforming to USP Class VI standard

Production Process--Strictly follow SOP for production and quality control

Exquisite product design, high precision forming, ultrasonic welding, no chemical addition.

Surface treatment--Tissue culture treated

The surface of the cell culture container is treated with hydrophilic treatment to ensure that the cells adhere to the surface more evenly and stable with better adsorption capacity.

Product expiration date verification

The cell growth surface can still meet the cell growth requirements after three years of aging, and there is no positive result of the sterility test.

Biosafety testing

Refer to <<State Food and Drug Administration National Standards for Packaging Materials and Containers in Direct Contact with Drugs (Series 6)>>, The product is tested for cytotoxicity, sensitization, intradermal irritation, acute systemic toxicity and hemolysis.

Physical and chemical safety testing

Refer to <<State Food and Drug Administration National Standards for Packaging Materials and Containers in Direct Contact with Drugs (Series 6)>>, The products are tested for insoluble particles, ignition residues, metal elements, and dissolved substances (clarity, color, pH, UV absorbance, non-volatile matter, easy oxides, heavy metals).

Process testing

In order to ensure the structure and strength of the product, it is necessary to verify the performance of relevant equipment, such as injection molding machines, molds, plasma equipment, welding machines, leakage meter and so on before production. After production, the product should be verified for sealing, strength, dropping and transportation.

Cell growth test

Cell growth homogeneity experiment.

Cell factory validation test--Sterility and particle guarantee

Product initial bioburden test, irradiation dose setting, dose review, aseptic packaging verification, irradiation process verification, product sterility and particle testing.

Applicable cells

VERO、MRC-5、2BS、293T、L-929

Packaging strength verification

The breakage rate is less than 3% after repeated long distance delivery challenges.

Sterility Guarantee--Imported Rhodotron® TT200 electron accelerator from Belgian IBA company, Self-built irradiation center.

The irradiation sterilization process has passed ISO 13485 and ISO 11137 quality system certification.

- Made of high clarity, 100% virgin polystyrene.
- Sterilized by E-beam, SAL=10⁻⁶.
- Non-Pyrogenic, DNase/Rnase free.
- Excellent welding line design can avoid producing particles during welding and make the biofactory stronger (Under Features 7th line).
- Vent caps with 0.22 μm hydrophobic filters for gas exchange without contamination.
- Wide mouth is applicable to pour culture medium directly. Narrow mouth is applicable to operate with the aseptic pipeline.
- Standardize operations to reduce batch differences.
- Individually packaged in double-layer sterile bags.
- TC treated, good for cell attachment and growth.
- Clear lot number for batch traceability.
- Ultrasonic welding without extrinsic ingredients.
- Standardize operations to reduce batch differences.
- Growth kinetics are the same as cells grow in the cell culture flasks. Applicable to large-scale culture adherent cells.
- Large growing area. Just a single operate, you can cultivate a large number of cells and reduce contamination risk.
- Applicable to automatic machine.

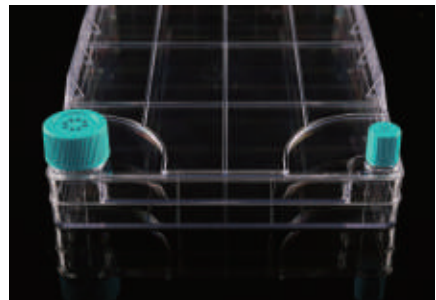
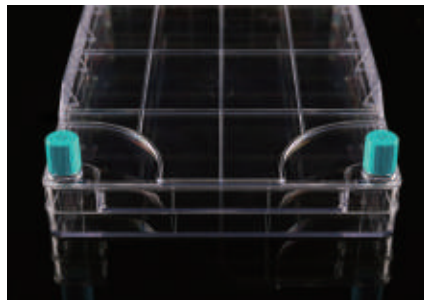
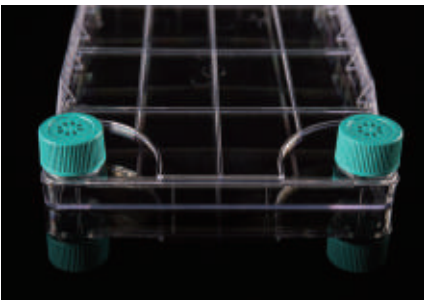
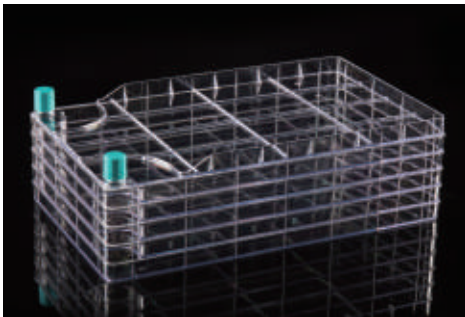
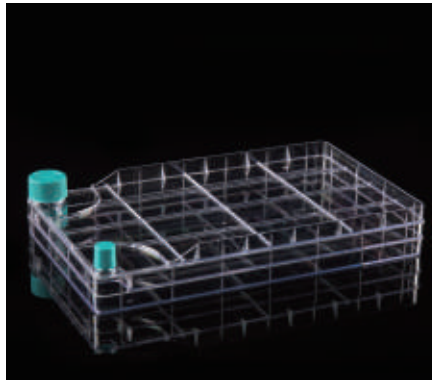

2 Wide Plug Seal Caps

2 Narrow Plug Seal Caps

1 Wide + 1 Narrow Plug Seal Cap

● BioFactory

Layer	Cultivation Area (cm ²)	Dimension (mm)			/Case	Seal Caps	Vent Filter Caps	Cat.No.		
		Length	Width	Height				2 Wide Plug	2 Narrow Plug	1 Wide + 1 Narrow Plug
1	632	335	205	44	8	16	16	771001	772001	773001
2	1264	335	205	61	8	16	16	771101	772101	773101
5	3160	335	205	112	4	8	8	771204	772204	773204
10	6320	335	205	197	6	12	12	771302	772302	773302
40	25280	335	205	712	2	4	4	771403	772403	773403

Large mouth design for easy pouring of the medium directly;

Small mouth design for easy connection with the feeding systems;

Vent Cap : 0.22 μm hydrophobic gas permeable membrane, hindering bacteria and water, can also avoid liquid swelling.

Guidelines for use

Cell culture



Pour the prepared suspension into the BioFactory (recommended volume of 150-200 mL per layer).



Turn the BioFactory Chamber 90° make sure the liquid at the same horizontal.



Turn the BioFactory™ Chamber 90° so that the filling and venting ports are up (as shown). It is normal for the medium level in the bottom chamber section to be slightly higher.



Gently lower the BioFactory Chamber to its normal horizontal incubation position and gently tilt the chamber back and forth until the surface of each chamber is completely covered with medium.



Put the BioFactory into the incubator.



Watch operation video

Precautions

1. Please pre-heat the cell factory and culture medium to the culture temperature: since it takes a long time for a large incubator to reach the set culture temperature, pre-heating the cell factory and culture medium to the culture temperature before starting the experiment may speed up cell attachment and significantly increase cell recovery.
2. Slow operating is required to avoid occurrence of air bubbles caused by sharp shaking: air bubbles may lead to flowing the medium from an upper layer to a lower layer.
3. Avoid spraying alcohol onto the breathable cover, since alcohol may wet the hydrophobic membrane filter and make it impermeable and consequently affect the gas exchange or cause pressure imbalance during operations.

Cell Harvest

1. After the culture is completed, pour the culture medium out.
2. Wash the factory with the calcium-free and magnesium-free phosphate buffer solution (CMF-PBS) (40-50 mL / layer) and if necessary, repeat the washing process.
3. Digestion: pre-heat the digestion solution (10-40 mL / layer) in advance.
4. Collection: centrifuge for 5 mins at 1000 rpm, remove the digestion solution and collect cells.
5. Washing: wash the incubator with CMF-PBS or culture medium after digestion.

Precautions

1. Ensure that the culture surface of each layer is completely immersed in the CMF-PBS, and gently shake the cell factory forward and backward to wash off the residual culture medium.
2. Distribute the digestion solution evenly to each layer; gently tilt the incubator forward and backward, left and right to ensure that the digestion solution has completely covered the culture surface; gently tap the incubator to help the cells detach from the surface.
3. Since it is unable to clearly observe the digestion status of the cells in the middle layers of a cell factory, it is recommended to refer to the digestion status of a culture flask or a single-layer cell factory under exactly the same culture conditions. Or, use a dedicated observation platform for multiple-layer cell incubators to observe the growth status of cells in each layer.
4. If there are numerous cells present in the washing solution or the culture layers of the cell factory, it is necessary to wash multiple times or adjust the procedure of cell digestion.
5. Even a slight deviation of the culture temperature may affect the cell harvest rate, so it is required to pay close attention as to whether or not the culture temperature is exactly the set temperature.

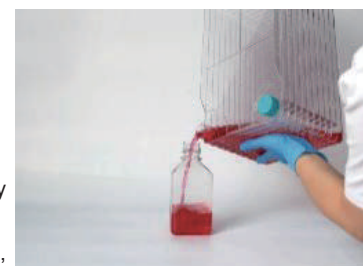

Biofactory Closed System Solution

● BioFactory (Cap with Over cap)

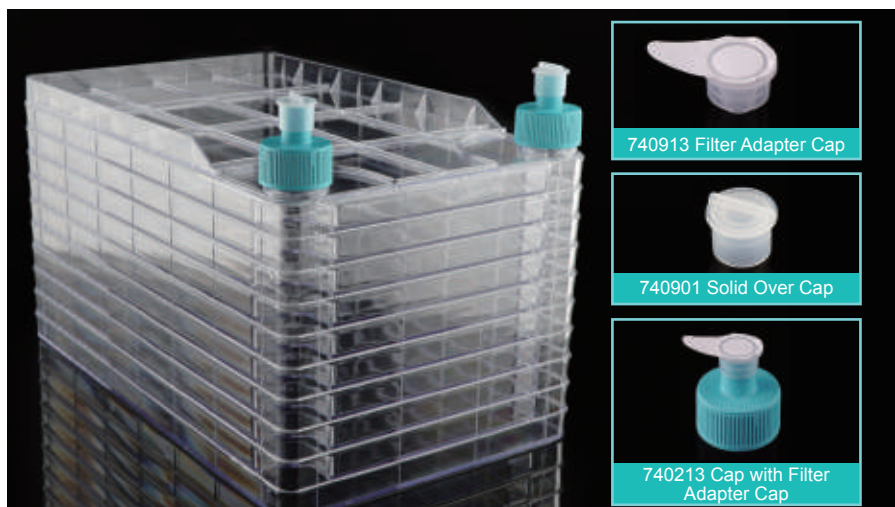

Vented Overcap and Solid Overcap can be used directly on the adaptor caps to block dust and bacteria. Vented Overcap is equipped with a 0.22 μm hydrophobic breathable membrane to achieve aseptic ventilation during liquid transfer.

 Accessory information can be found on page 35.

Layer	Description	Comes with Vented Overcap	/Case	Cat.No.
10	2 Sterile Vented over caps	12	6	771322
40	2 Sterile Vented over caps	4	6	771422

● BioFactory (-20 °C Frost Resistance)

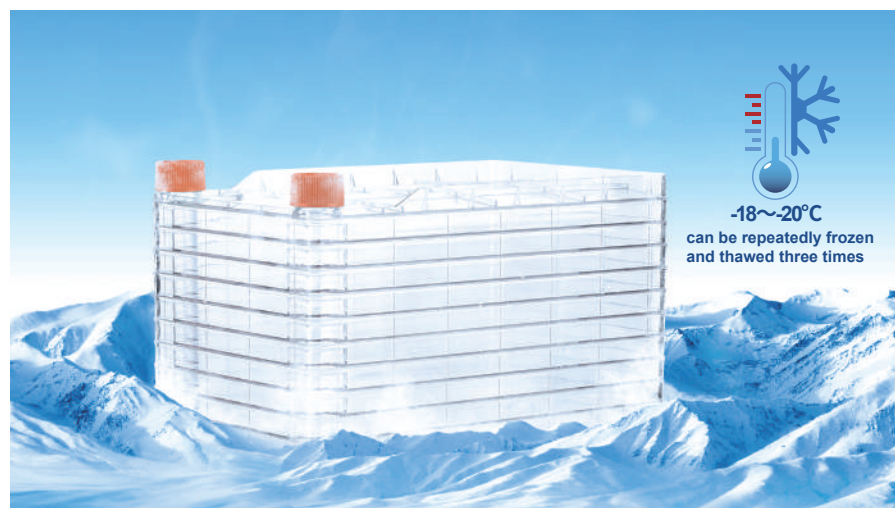

The NEST freeze-resistant BioFactory adopts a dispensing technique to glue different layers, thus its freeze resistance is upgraded. It can withstand freezing at -18 ~ -20 °C, and can be repeatedly frozen and thawed three times, with better firmness.

Reminder: Due to the principle of thermal expansion and cold contraction, after the BioFactory uses a sealed cap to fill the culture media and freezes, the bottom or top layer may be slightly deformed. This is an inevitable and normal phenomenon, and there will be no leakage and will not affect normal use.

Layer	Cultivation Area (cm ²)	Dimension (mm)			Description	Package	Cat.No.
		Length	Width	Height			
10	6320	335	205	201	Double Large mouth, TC, sterile	Double bag package, 1 pc / bag, 6 pcs / case	771392

Biofactory Closed System Solution

To customize a NEST Biofactory Closed System Solution that meets your needs, follow these steps:

Step 1



- Choose the Layer

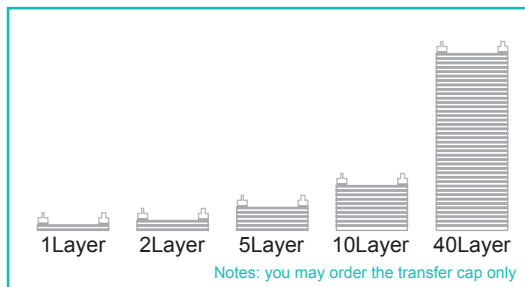

Generate custom graphics by submitting your request on www.cell-nest.com



Step 2



- Choose the cap type

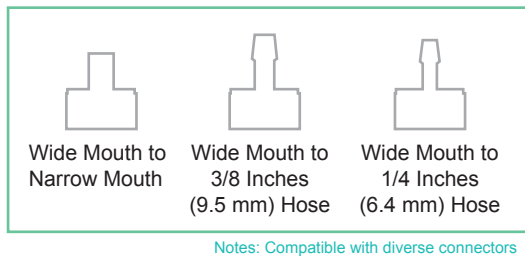

Step 3



- Choose the tube size/length
- Choose the tube material

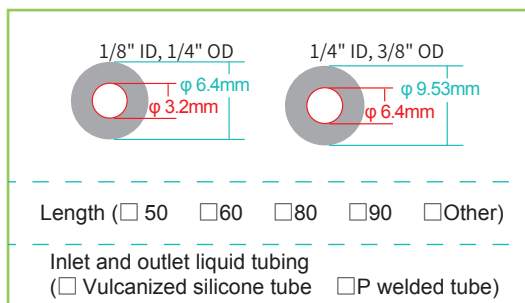

Step 4



- Choose the membrane area Air filter (PVDF membrane)

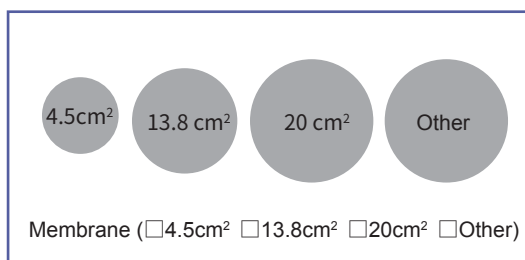

Step 5



- Choose the connector type

- ① Luer connector (male and female)
- ② MPC connector (male and female)
- ③ Heat sealing (no connector)

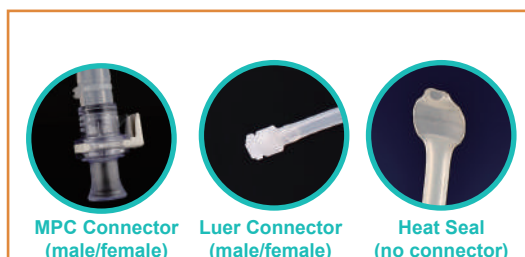

= Results



Inform our sales or product engineer of your choice if you have completed your selection.

Biofactory Closed System Solution

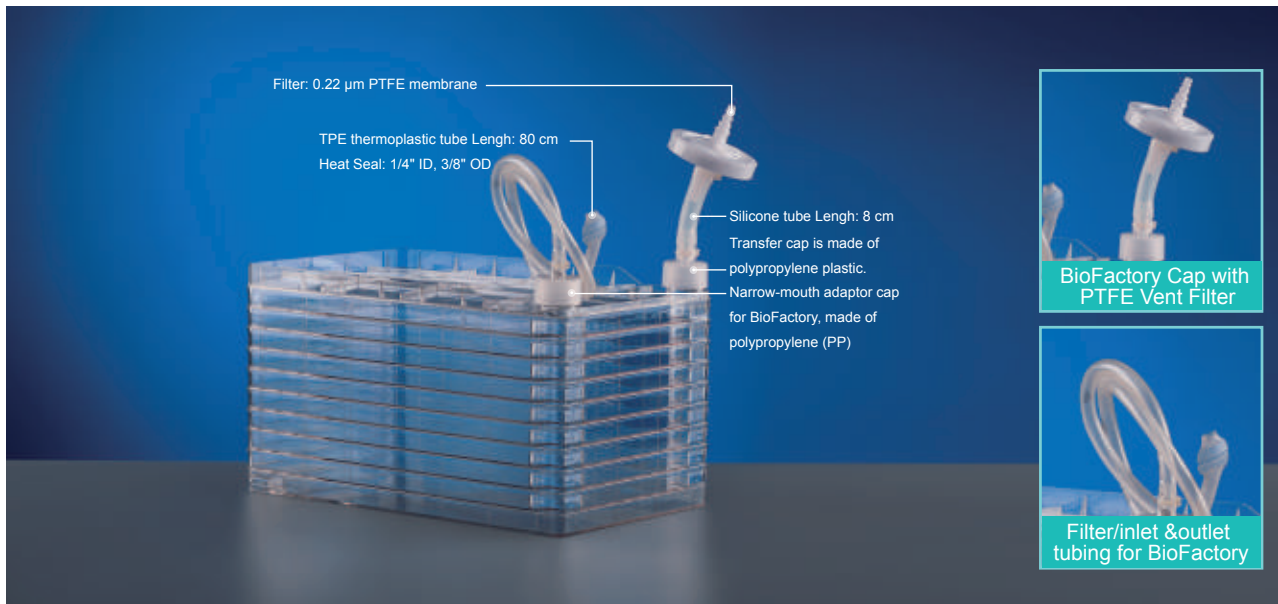

- Closed liquid transfer, avoiding open operation and reducing the risk of pollution in the process of liquid transfer.
- The liquid inlet tube can be aseptically welded under a normal environment.
- High-quality materials and smooth inner wall of the tube, ensuring an excellent transmission performance.
- Electron beam sterilization, SAL = 10^{-6} .
- No endotoxin and no components of animal origin.

 Accessory information can be found on page 35.

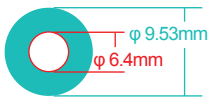
Layer	Cultivation Area (cm ²)	External Liquid Transfer Tube			0.2µm Filter Membrane area	/Case	Cat.No.
		Dia.	Length	Connector			
5	3160	 TPE Tube: 1/4" ID, 3/8" OD ϕ 9.53mm ϕ 6.4mm	80 cm	Heat Seal	20 cm ²	2	C71754-BZD080A
10	6320						C71554-BZD080A

Accessories

BioFactory Accessories



Description	/Pack	/Case	Cat.No.
Wide Mouth Seal cap for BioFactory	1	10	740001
Wide Mouth Vent cap for BioFactory	1	10	740011
Narrow Mouth Seal cap for BioFactory	1	10	740101
Narrow Mouth Vent cap for BioFactory	1	10	740111

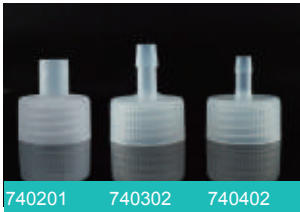

Description	Size(mm)		/Pack	/Case	Function	Cat.No.
	ID	OD				
Adaptor Cap	11.8	14.3	1	10	Wide Mouth to Narrow Mouth	740201
Adaptor Cap	7.3	14.3	1	10	Wide Mouth to 3/8 Inches(9.5 mm) Hose	740302
Adaptor Cap	5.9	8.8	1	10	Wide Mouth to 1/4 Inches(6.4 mm) Hose	740402



Description	/Pack	/Case	Cat.No.
Filter Adapter Cap	1	20	740913
Solid Over Cap	1	20	740901
Cap with Filter Adapter Cap	1	10	740213



C71254-ZMC000B

Filter/inlet & outlet tubing for BioFactory

BioFactory Cap with PTFE Vent Filter (0.22 µm Φ42mm), without BioFactory, Sterile
1 /Pack, 4 /Case



C71255-ZMD000B

Filter/inlet & outlet tubing for BioFactory

BioFactory Cap with PTFE Vent Filter (0.22 µm Φ50mm), without BioFactory
1 /Pack, 4 /Case

C71254-FBA080B

Filter/inlet & outlet tubing for BioFactory

BioFactory Cap with Silicon Tube (80cm 1/4 " ID3/8" OD), Male CPC Connector with Female Sealing Cap, without BioFactory, Sterile
1 /Pack, 4 /Case

C71255-HCA080B

Filter/inlet & outlet tubing for BioFactory

BioFactory Cap with Silicon Tube (80cm 3/8 " ID5/8" OD), Male CPC Connector with Female Sealing Cap, without BioFactory, Sterile
1 /Pack, 4 /Case



741001 Adaptor Connector

Adaptor Connector to 3/8 Inches (9.5 mm)Hose
 1 pcs / pack
 Compatible with transfer cap and narrow mouth
 One end is designed to fit the narrow mouth of BioFactory and the other end connects to a hose with a 3/8" ID



C71200-ZME000B

Hose Clamp*1 (743001) Intended for hoses with an OD ranging from 12mm to 18mm.
Vent Filter *1 (742001) Hydrophobic membrane: PTFE, Pore size: 0.2 µm
 Membrane area: 20 cm².
Silicone Ring*2
SPT-50 Hose*1 (15cm) (744001) ID: 3/8" (9.5mm) , OD: 5/8" (15.9mm)



C71275-ZME000B

Hose Clamp*1 (743001) Intended for hoses with an OD ranging from 12mm to 18mm.
Vent Filter *1 (742001) Hydrophobic membrane: PTFE, Pore size: 0.2 µm
 Membrane area: 20 cm².
2 different Adaptor Caps*1 (741001) PTFE Material , ID:7.3mm
 Serrated OD: 10 mm
Silicone Ring*2
SPT-50 Hose*1 (15cm) (744001) ID: 3/8" (9.5mm) , OD: 5/8" (15.9mm)



745001 BioFactory AccessoryLite Package

Adaptor Cap*1 (740201) Wide mouth to narrow mouth
Adaptor Cap*1 (740302) ID 3/8"
2 different Adaptor Caps*1 (741001)
Vent Filter *1 (742001) Hydrophobic membrane: PTFE, Pore size: 0.2 µm
 Membrane area: 20 cm².
Hose Clamp*1 (743001) Intended for hoses with an OD ranging from 12mm to 18mm.
SPT-50 Hose*1 (15cm) (744001) ID: 3/8" (9.5mm) , OD: 5/8" (15.9mm)
 1 pcs / pack



751101 BioFactory Holder, Individually Wrapped

Material: aluminum alloy and silicone
 1 pcs / pack, 5 pcs / case
 Function: to tilt for easy transfer
 Features:
 The double "N" latch makes the width adjustable; the anti-slip silicone mat attached avoids abrasion and secures the stability.
 Multiple adjustable positions for desired height

Notes:
 ①Position 2 or 3 is recommended(Recommended working volume for each layer of BioFactory:150ml to 200ml)
 ②It is necessary to tilt the BioFactory forward manually to ensure all the liquid flows out when there is a small amount of liquid.

Square Bottle & Closed System Solution



Square Storage Bottle is a reagent storage container commonly utilized in laboratories. NEST offers Square Storage Bottles in PET, PETG, and PC materials. Additionally, a fresh range of PET bottles featuring a classic square shoulder design is recently launched, offering a wider variety of specifications and liquid storage solutions.

The bottle body has high transparency, high mechanical strength, and strong impact resistance, making it convenient for observation and transportation.

- The material has strong tolerance, low temperature resistance, UV resistance, and is not easy to crack.
- The smooth inner surface minimizes the residue on the inner wall.
- Non-cytotoxic, non-pyrogenic, and free of animal-derived components

Square Bottle



Structural Features

- **Cap:** the mold for cap is specifically designed. The cap is formed through one-shot moulding without inner gasket, enabling it closer attached to the body for better sealing performance.
- **Bottleneck:** smooth buckle design reduces residue inside.
- **Body:** it has high transparency, high mechanical strength, strong impact resistance, and is convenient for observation and transportation. The smooth inner surface minimizes the residue on the inner wall. And the thickness of the bottle wall is uniform for better anti-crack and anti-puncture capacity.
- **Bottom:** the bottom has curved inner corners that are easy to clean, and the bottom is injection molded with raw material information.

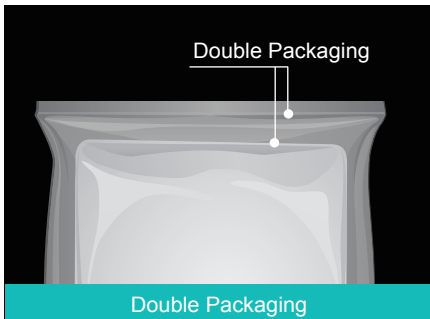

Double Packaging



Double Whole Bag Package



Tray package

Double-layer Packaging

- **Enhanced protection:** double-layer packaging offers additional protection for safety in case the bottles were damaged by external forces such as extrusion, vibration, and collision during transportation.
- **Improved durability:** double-layer packaging ensures durability and a longer service life.
- **Compliance:** in line with material entry requirements of the GMP purification workshop of the biological laboratory.

Double-layer Large Packaging

- **Economical and cost-effective:** reducing costs of packaging and labor
- **Improve efficiency:** reducing the redundant loading and unloading operations for industrial customers when filling liquid, speeding up the efficiency and reducing the labor intensity.

Tray-packed

- The tray-packed bottles feature a one-piece plastic sealing coating by packaging equipment, which ensures better protection and less collision between and prevents contamination and loss.
- High space utilization by stacking.

Volume (mL)	Double Packaging					Double Whole Bag Package			Tray package			
	/Pack	/Case	PET	PETG	PC	/Pack	/Case	PET	/Pack	/Case	PETG	PC
30	5	40	/	354111	354314	/	/	/	40	280	354113	354313
60	6	48	354611	354511	354714	40	200	354614	40	200	354513	354713
125	6	48	353611	353511	353314	24	192	353614	24	96	353513	353313
250	6	48	352611	352511	352314	30	120	352614	30	60	352513	352313
500	8	24	333001	333511	333314	20	80	333004	20	40	333513	333313
1000	4	12	334001	334511	334314	12	48	334004	12	24	334513	334313

Square Storage Bottle Closed System Solution

To customize a NEST Square Storage Bottle Closed System Solution that meets your needs, follow these steps:



Step 1

- Choose the bottle capacity
- Choose the bottle material

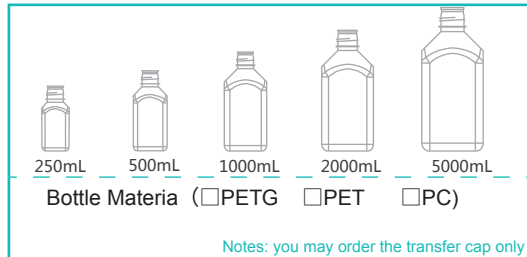

Generate custom graphics by submitting your request on www.cell-nest.com



Step 2

- Choose the cap type

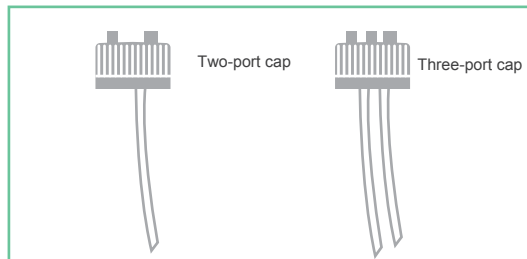

Notes: Compatible with diverse connectors



Step 3

- Choose the tube size/length
- Choose the tube material

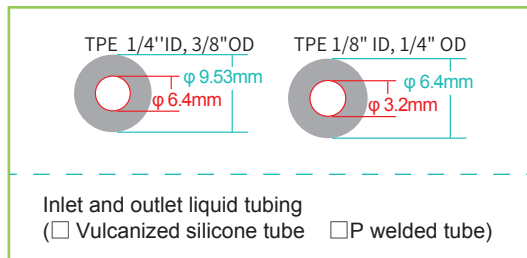

Step 4

- Choose the membrane area Air filter (PVDF membrane)

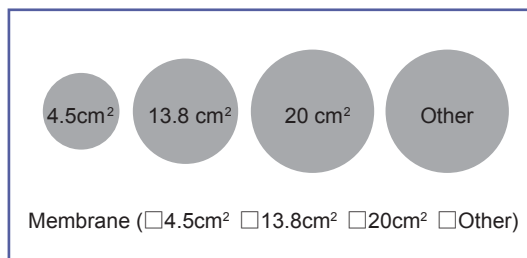

Step 5

- Choose the connector type
- ① Luer connector (male and female)
 - ② MPC connector (male and female)
 - ③ Heat sealing (no connector)

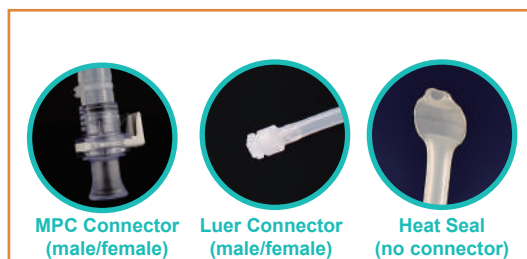

Inform our sales or product engineer of your choice if you have completed your selection.

Square Storage Bottle Closed System Solution



● Product Description

The newly launched NEST Closed System collection provides an aseptic liquid infusion solution for pharmaceuticals, biotechnology industry and laboratories. A standard Luer head is used in the joint of the system, enabling the operation more convenient. Also, the TPE material of tubes is in line with the requirements for industrial pharmaceutical enterprises, and is validated by a certified third party in accordance with BPOG Guide for Evaluating Extractables and Leachables.

● Application

- Various tubing specifications
- The injection-molded transfer cap is highly compatible with other major brands.
- The bottle body is made of PETG, which has high transparency, mechanical strength, low-temperature resistance, and UV resistance, making it suitable for observation and transportation.
- The unique external thick collar design of the bottle neck secures a sealed environment for experiments.
- Non-cytotoxic, non-pyrogenic, no animal-derived components.

● Closed System Solution (Bi-Directional Transfer Cap)

Volume (mL)	Tube Material			0.2µm Filter Membrane area	/Case	Cat.No.	
	Dia.	Length	Connector			Closed System Solution	Aseptic Transfer Caps
250		60cm	Female Luer Lock Connector with Luer Plug	4.5cm ²	10	C50921-BHB060A	C50921-BHB060B
500						C51021-BHB060A	C51021-BHB060B
1000						C51121-BHB060A	C51121-BHB060B
250		60cm	Male MPC connector with Female Sealing Cap	4.5cm ²	10	C50921-BBB060A	C50921-BBB060B
500						C51021-BBB060A	C51021-BBB060B
1000						C51121-BBB060A	C51121-BBB060B
250		60cm	Female Luer Lock Connector with Luer Plug	4.5cm ²	10	C50922-AGB060A	C50922-AGB060B
500						C51022-AGB060A	C51022-AGB060B
1000						C51122-AGB060A	C51122-AGB060B
250		60cm	Male MPC connector with Female Sealing Cap	4.5cm ²	10	C50922-AAB060A	C50922-AAB060B
500						C51022-AAB060A	C51022-AAB060B
1000						C51122-AAB060A	C51122-AAB060B

● Closed System Solution (3-Port Transfer Cap)

Volume (mL)	Tube Material			0.2µm Filter Membrane area	/Case	Cat.No.	
	Dia.	Length	Connector			Closed System Solution	Aseptic Transfer Caps
1000		60cm	Female Luer Lock Connector with Luer Plug	4.5cm ²	10	C511AB-AGB060A	C511AB-AGB060B

Carboy



• Product Description

The barrel, the tap and the screw cap of the carboy are made from polypropylene (PP) and the gasket is made from thermoplastic elastomer (TPE), all of which are autoclavable for sterilization before use to prevent the growth of bacteria and other microorganisms. It is mainly used for storing and dispensing solutions, culture medium, also ideal for sterile water. The barrel is moulded with a 1-gallon or 5 liter scale markings for easy identification of liquid levels during operation. The sealing performance is secured by the TPE gasket and the thread on the finish, which is well matched to the cap.

• Application

- Storage container for raw pharmaceutical materials or culture media that require autoclaving sterilization.
- Storage container for bulk raw pharmaceutical materials or other substances.
- Storage container for sterile water.

Volume (mL)	With Handle	Sterilization	/Case	With Tap	Without Tap
10	YES	NO	4	789001	789011
20	YES	NO	3	789101	789111

Accessories



744001 SPT-50 Hose

Inner Dia # 3/8 Inches (9.5 mm)
Outer Dia # 5/8 Inches (15.9 mm)
50 Inches/ 15 meters
1 pcs / pack
Application: linking tubings for filling and draining operations

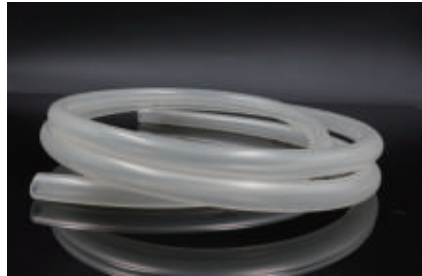

746001 C-Flex Welding Hose

Inner Dia# 3/8 Inches (9.5 mm)
Outer Dia# 5/8 Inches (15.9 mm)
50 Inches/ 15 meters
1 pcs / pack
Application: linking tubings for filling and draining operations, heat weldable.



747001

747011

747001 CPC Connector

CPC & PC Material
Packaging: individual sterile packaging, 5 prs/cs
(Inner Dia #3/8) for Hose to Hose Connecting
1 pcs / pack, 5 pcs / case

747011 CPC Sealing Plug

10 pcs / case



743001 Hose Clamp

Hose clamp for 12-18 mm diameter hose
10 pcs / pack



751001 Y Shape Connector

PP Material
Y Shape CPC Connector for Inner Dia #3/8
Hose
1 pcs / pack, 5 pcs / case



749001 T Shape Connector

PP Material
T Shape CPC Connector for Inner Dia #3/8
Hose
1 pcs / pack, 5 pcs / case



742011 0.22µm Vent Filter

Pore size:0.22 µm Membrane area: 13.8 cm²
1 pcs / pack, 5 pcs / case

742001 0.22µm Vent Filter

Hydrophobic membrane : PTFE
Pore size:0.2 µm Membrane area: 20 cm²
Packaging: individual sterile packaging, 1 pcs / pack, 5 pcs / case
Application: Hose fitting



Biobank System

Cryogenic Tubes

Cryogenic tubes, also known as freezing tubes, are commonly used for low-temperature preservation. They are a crucial laboratory consumable in the biological, pharmaceutical, food, and other industries. Made of medical-grade polypropylene (PP), cryogenic tubes can withstand low temperatures down to minus 196°C in a liquid nitrogen gas phase environment. They are available in three types: cryogenic tubes (without 2D barcode), 2D barcode cryogenic tubes and 3-code cryogenic tubes.



✓ High-quality raw materials:

Top-quality and food grade resin, which complies with USP class 6, pharmaceutical and laboratory standards, is adopted. It contains much lower concentrations of trace element extractables than glass.



✓ High-Precision Technology:

Equipped with high-precision injection-stretch-blow molding equipment and automated equipment for manufacturing.



✓ Multiple Specifications:

Multiple materials and specifications are available, including PET, PETG, HDPE that are resistant to chemical corrosion, as well as PP and PC products that are autoclavable. The packaging mode of square reagent bottles can be customized to meet any needs. SBS Format Cryogenic Tubes fits automated equipment.

✓ High Quality Standards:

Certified by ISO13485 and ISO 9001, with batch stability.

✓ Economical and Environmentally Friendly:

Some products are reusable and extremely durable, reducing the waste of disposable containers and preventing the leakage of harmful substances, making them environmentally friendly.

Complete stability and safety verification reports

Manufacturing enterprise certification		Production process, quality standards, storage, transportation and use verification		Testing by third-party authoritative professional inspection and testing organizations		
Qualification certificate	ISO 9001, ISO13485	Process test	Injection molding machine, mold performance verification	Biological testing GB/T16886.5-2017 GB/T16886.4-2003 GB/T16886.10-2017 GB/T16886.11-2021	In vitro cytotoxicity test	
	FDA, CE		Sealing test		Skin sensitivity test	
	Irradiation ISO 13485, ISO 11137		Cryogenic test		Skin irritation test	
Sterility testing laboratory	ISO 7 requirements	Performance test	High-temperature sterilization test	GB/T16886.10-2017 GB/T16886.11-2021	Acute systemic toxicity test	
	GB 50591-2010		DNase/RNase		Hemolysis test	
	GB/T 16294-2010		Endotoxin		Heavy metal content of materials Pb, Sn, Cd, Cr	
Level 100000 clean workshop environmental testing	ISO 8 requirements	Sterility and particle assurance	Bottom 2D barcode integrity test	Physical and chemical testing GB/T14233.1-2008	Reducing substances	
	GB 50073-2013		Irradiation process verification		Leachable testing	pH
	YY0033-2000		Sterile packaging verification			Evaporation residue
Purified Water System Validation	GMP requirements	Product sterility test		UV absorbance		
Raw material verification	Physical and chemical testing Extractable testing	Insoluble particle detection				
		Drop and transportation verification				



Cryogenic Tubes



• Volume optimization

Volume selection based on quantity and type of sample.



• Improved sealing effect

Soft rubber sealing surface design, passing vacuum test, ensuring sample safety.



• Material upgrade

New polymer material, improved cryogenic and anti-aging performance, high-temperature and high-pressure sterilization.

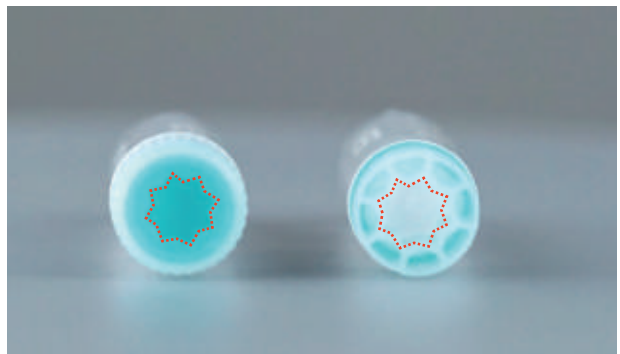

• Suitable for automation

"Eight-petal plum" design, reduces manual process, contamination risk, and labor cost.

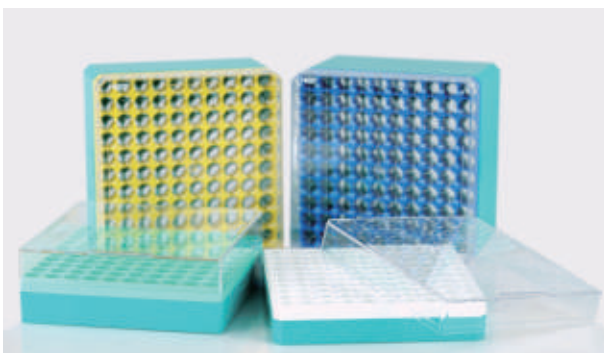

• More specifications

Filling gap for 4 mL, 5 mL, and 10x10 box series, meeting various research needs.



• Multi-color cap inserts

Color-coded cap inserts for easy sample identification.

Cryogenic Tubes



Cap Type	External thread cap				Internal thread cap			
Capacity (mL)	1.5	2.0	4.0	5.0	1.5	1.8	4.0	5.0
Overall height (mm)	40.7	45.5	76.3	93.3	40.7	45.5	76.3	93.3
Size parameters (mm)	10				8.3			
Outer diameter Φ (mm)	12.85				12.10			
Temperature Range	-196 to 121°C				-196 to 121°C			

Note:

1. The thread of the external thread cap is not directly exposed to the outside, which minimizes the possibility of cross-contamination;
2. The internal thread cap has the same diameter as the cryogenic tube, which has an advantage in intensive storage applications;
3. The maximum volume of the external thread cap is closer to the nominal volume than the internal thread cap. Since the content volume usually increases during liquid freezing, the recommended usage volume of both external and internal thread cap cryogenic tubes is 80% of the maximum volume;
4. Both storage methods are aimed at ensuring the safety of cryogenic storage and can be freely selected according to the actual user needs.



Cryogenic Tubes

● Cryogenic Tubes (without 2D barcode) – Bag Package

Product Number	Capacity (mL)	Cap Type	Quantity /Bag	Bags /Box	Box /Case
618901	1.0	External thread	96	/	10
606901	1.5	External thread	50	10	4
607401	2.0	External thread	50	10	4
608401	4.0	External thread	50	5	4
609401	5.0	External thread	50	5	4
606801	1.5	Internal thread	50	10	4
607301	1.8	Internal thread	50	10	4
608301	4.0	Internal thread	50	5	4
609301	5.0	Internal thread	50	5	4



*The dimensions of the cryogenic box are detailed on page 09

● Cryogenic Tubes (without 2D barcode) - Rack Package

Product Number	Capacity (mL)	Cap Type	Pack-aging	Quantity /Rack	Racks /Case
618906	1.0	External thread	8*12	96	10
606902	1.5	External thread	10*10	100	14
607402	2.0	External thread	10*10	100	12
608402	4.0	External thread	10*10	100	8
609402	5.0	External thread	10*10	100	6
606802	1.5	Internal thread	10*10	100	14
607302	1.8	Internal thread	10*10	100	12
608302	4.0	Internal thread	10*10	100	8
609302	5.0	Internal thread	10*10	100	6



*The dimensions of the cryogenic box are detailed on page 09

● 2D Barcode Cryogenic Tubes - Rack Package

Product Number	Capacity (mL)	Cap Type	Pack-aging	Quantity /Rack	Racks /Case
606952	1.5	External thread	10*10	100	14
607452	2.0	External thread	10*10	100	12
608452	4.0	External thread	10*10	100	8
609452	5.0	External thread	10*10	100	6
606852	1.5	Internal thread	10*10	100	14
607352	1.8	Internal thread	10*10	100	12
608352	4.0	Internal thread	10*10	100	8
609352	5.0	Internal thread	10*10	100	6
612891	2.0	External thread	6*8	48	10
614591	4.0	External thread	6*8	48	10

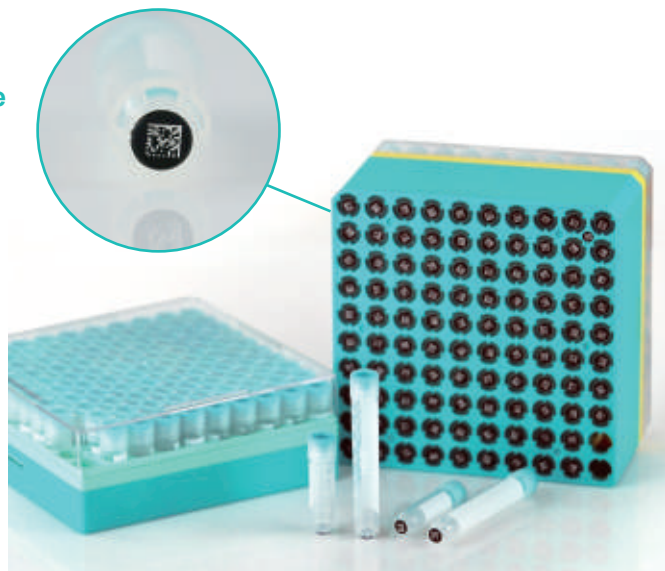

*The dimensions of the cryogenic box are detailed on page 09

SBS Format Cryogenic Tubes

Sealing design

- New sealing structure design, optimized sealing performance, better liquid nitrogen sealing, smoother feel.

High-quality raw materials

- Made of medical-grade high-purity polypropylene, ultra-high rigidity toughening material, excellent weather resistance, compliant with ISO10993 standards.
- No DNase, no RNase, no endotoxin.

Encoding rules

- Three-code-in-1 composed of DATAMATRIX code, barcode and readable code, laser-etched on the bottom and side of the tube.
- Codes are high contrast for easy reading, scratch-resistant, not easy to fall off, resistant to DMSO and other organic solvents.
- High uniqueness of laser-etched international standard DATAMATRIX codes.

At the same time, NEST can customize exclusive encodings for you. If you have any requirements, please contact us. For more information, please visit our official website at www.cell-nest.com.

Quality assurance

- Produced in GMP 100,000-level clean room certified according to ISO 9001, ISO 13485 quality system certification.
- Strict production process, well-developed management system to ensure batch quality stability.

Sterility assurance

- E-beam sterilization, SAL=10⁻⁶.

Box features

- Cryogenic box identifier code: We have a unique QR code at the bottom of the rack and a one-dimensional barcode laser engraved on the side of the rack. When reading the cryogenic tube information, the box information is also read to automatically locate the rack and achieve a safer sample traceability.
- Box lid buckle: The cryogenic box is designed with a buckle that can tightly fit with the box to prevent scattering when dropped. The buckle switch is also convenient and does not fail even after being frozen in liquid nitrogen, ensuring sample safety.



External thread cap

Internal thread cap

SBS Format Cryogenic Tubes



Cap Type	External thread cap							Internal thread cap		External thread cap	
Capacity (mL)	0.5	0.75	1.0	2.0	4.0	6.0	8.0	0.5	1.0	4.0	1.9
Overall height (mm)	27.6	37.3	45.6	45.5	76.3	57.5	71.7	33.5	51.4	76.76	42.96
Size parameters (mm)	5.3		10		10.3		6.55				
Outer diameter Φ (mm)	8.85		12.85		17.8		8.7		12.8		
Temperature Range	-196 to 121°C							-196 to 121°C			

Note:

1. The thread of the external thread cap is not directly exposed to the outside, which minimizes the possibility of cross-contamination;
2. The internal thread cap has the same diameter as the cryogenic tube, which has an advantage in intensive storage applications;
3. The maximum volume of the external thread cap is closer to the nominal volume than the internal thread cap. Since the content volume usually increases during liquid freezing, the recommended usage volume of both external and internal thread cap cryogenic tubes is 80% of the maximum volume;
4. Both storage methods are aimed at ensuring the safety of cryogenic storage and can be freely selected according to the actual user needs.



Bag Package

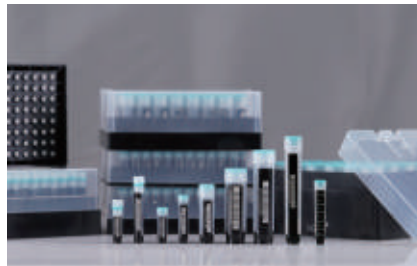

Rack Package



Yellow Cap

● SBS 3-Code Cryogenic Tubes - Bag Package

Product Number	Capacity (mL)	Cap Type	Quantity /Bag	Bags /Case
612541	0.5	External thread	96	10
612641	0.75	External thread	96	10
612741	1	External thread	96	10
612841	2	External thread	48	10
614541	4	External thread	48	10
614641	6	External thread	24	10
614741	8	External thread	24	10
612521	0.5	Internal thread	96	10
612721	1	Internal thread	96	10
612041	1.9	External thread	48	10
614041	4.0	External thread	48	10

Yellow Cap

● SBS 3-Code Cryogenic Tube - Rack Package

Product Number	Capacity (mL)	Cap Type	Quantity /Rack	Racks /Case
612551	0.5	External thread	96	10
612651	0.75	External thread	96	10
612751	1	External thread	96	10
612851	2	External thread	48	10
614551	4	External thread	48	10
614651	6	External thread	24	10
614751	8	External thread	24	10
612531	0.5	Internal thread	96	10
612731	1	Internal thread	96	10
612051	1.9	External thread	48	10
614051	4.0	External thread	48	10

Yellow Cap

Cap Inserts, Cryogenic Box

● Cap Inserts



Product Number (NEW)	Color	Sterilization	Packaging	
			Quantity/Bag	Bags/Case
611201	White	No	100	10
611202	Red	No	100	10
611203	Yellow	No	100	10
611204	Blue	No	100	10
611205	Green	No	100	10
611206	Purple	No	100	10

*The new Cryogenic Vial Labels are exclusively designed to work with NEST's latest collection of Cryogenic Vials.

● Cryogenic Box



1.5 mL



2.0 external thread/1.8 internal thread



4.0 mL



5.0 mL



3-Code-in-1 Cryogenic Vial

- PC transparent cover, PC-ABS high-strength composite material base.
- Temperature range from -196°C to 70°C.
- Alphanumeric grid for easy sample labeling and identification.
- Each box contains drainage holes and vents, which accelerate the discharge of cold air and reduce condensation.
- Packaging with independent product and batch identification for quality traceability.

● Cryogenic Box

Product Number	Compatible Cryogenic Tube Capacity (mL)	Format (Holes)	Size (L x W x H)	Color	Sterilization	Quantity/Box
616651	1.5	10*10	133.6×133.6×44	White	No	14
616051	2.0 external thread/1.8 internal thread	10*10	133.6×133.6×48.8	Green	No	12
616151	4.0	10*10	133.6×133.6×79.5	Yellow	No	8
616551	5.0	10*10	133.6×133.6×96.5	Blue	No	6

● 3-Code-in-1 Cryogenic Vial

Product Number	Compatible Cryogenic Tube Capacity (mL)	Format (Holes)	Size (L x W x H)	Sterilization	Quantity/Box
616041	2.0	8*6	127×85.3×48.3	No	10
616841	6.0	4*6	127×85.3×60.4	No	10

*The new Cryogenic Box are exclusively designed to work with NEST's latest collection of Cryogenic Vials.

Defrosting Device

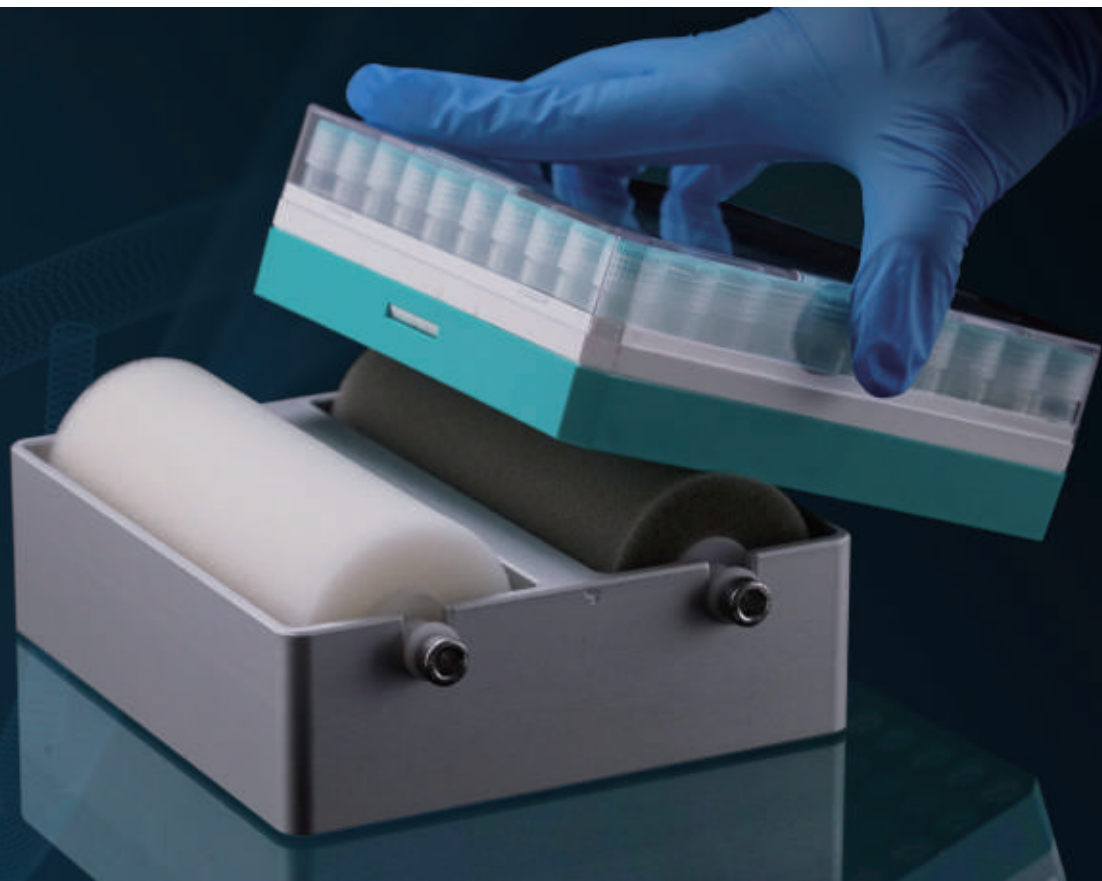

● Product introduction

The NEST defrosting device is a tool used to quickly remove frost from the bottom of boxed cryogenic vials. When cryogenic vials are stored in liquid nitrogen vapor phase or -80°C freezer, ice can form at the bottom of the vials. However, to ensure the rapid reading of cryogenic vial decoding systems, it is necessary to clearly identify the 2D code at the bottom of the vial. Therefore, rapid defrosting has become a necessary step.

● Features

- Wide compatibility: can be used for 24, 48, 96, and 384 formats of different brands of cryogenic boxes.
- Sample integrity: achieves bottom defrosting without heating, and the sample can still maintain a frozen state.
- Practicality: sponge roller is easy to assemble. The first roll requires the addition of a special reagent, and the second roll dries it, making it easy to use.

● Workflow



Add ethanol or isopropanol to infiltrate the white sponge.

Repeat the process multiple times until the frost is completely removed.

Product name	Defrosting device	Consumables for the defrosting device	Sponge
Product number	106001	Product number	106003/106004
Base material	Aluminum alloy	Material	High-quality sponge
Defrosting part	High-quality sponge	Color	White/Brown
Supporting reagent	Ethanol	Packaging method	1 piece/pack

Vertical Freezer Racks



Product number	Size (mm)	Maximum number of boxes	Size of boxes (mm)	Pcs/Case
200301	454H x 143D x 140W	8	133x133x51	6
200302	677H x 143D x 140W	12	133x133x51	6
200303	724H x 143D x 140W	13	133x133x51	6
200304	789H x 143D x 140W	14	133x133x51	6
200305	845H x 143D x 140W	15	133x133x51	6

Product number	Size (mm)	Maximum number of boxes	Size of boxes (mm)	Pcs/Case
200321	492H x 143D x 140W	6	133x133x75	6
200322	653H x 143D x 140W	8	133x133x75	6
200323	724H x 143D x 140W	9	133x133x75	6
200324	814H x 143D x 140W	10	133x133x75	6

Product number	Size (mm)	Maximum number of boxes	Size of boxes (mm)	Pcs/Case
200341	413H x 143D x 140W	4	133x133x98	6
200342	616H x 143D x 140W	6	133x133x98	6
200343	717H x 143D x 140W	7	133x133x98	6



Sample Freezing Recommendations

Safety Risks and Recommendations:

NEST cryogenic vials are made of polypropylene (PP), which has good chemical resistance and low-temperature performance. The temperature range for using cryogenic vials is -196°C to 121°C. They can be sterilized at high temperature and high pressure or placed in liquid nitrogen vapor.

However, it is not recommended to store them in liquid nitrogen due to the risk of cross-contamination. Liquid nitrogen has very low surface tension, which can cause it to flow into tightly capped cryogenic vials. After removing a cryogenic vial, residual liquid nitrogen may vaporize, creating explosion and injury risks.

If the sample has already been stored in the liquid phase of liquid nitrogen, the following measures are recommended to reduce the risks:

- Place the cryogenic box and cryogenic vial in liquid nitrogen vapor phase for 24 hours before removing from the liquid nitrogen tank to allow the liquid nitrogen to evaporate.
- When handling, be sure to wear protective goggles and gloves to prevent cryogenic vial rupture.
- Add a cryogenic vial sleeve before freezing the sample.

Please note that correct use and storage of cryogenic vials are critical steps to ensure the quality and safety of biological samples. Therefore, please follow the correct operating procedures and safety measures when using and storing cryogenic vials to ensure the reliability of biological sample quality and research results.

Preserving Sample Activity



- When handling low-temperature samples, it plays the role of a portable refrigerator, quickly cooling and temporarily stabilizing the temperature, maximizing the preservation of cell, nucleic acid, protein, and other sample activities.
- Suitable for tissue culture incubators, biosafety cabinets, and other limited space situations.

Ice Free Cool Box

Product number	Size (mm)	Weight (g)	Application
200103	152x170x123	1300	Includes 200902 ice core and 2mL module 200904
200901	152x170x123	140	Without ice core and module, multiple cooling sources and modules can be selected.

Ice Core

Product number	Product name	Temperature range	Freezer temperature	Freezing time	Size (mm)
200902	Cold core	0.5°C~4°C	-20°C	4h+	105 x 100 x 26
		0.5°C~4°C	-80°C	2h+	105 x 100 x 26
200903	Freezing core	-18°C~-4°C	-20°C	6h+	105 x 100 x 26
		-18°C~-4°C	-80°C	3h+	105 x 100 x 26

Module

Product number	Product name	Size (mm)	Application
200904	2 mL module	119*101*38	30 holes for 2 mL cryogenic vials
200905	1.5 mL module	119*101*38	48 holes for 1.5 mL cryogenic vials
200906	5 mL module	119*101*38	30 holes for 5 mL cryogenic vials
200907	PCR module	119*101*38	96 PCR holes



- Used for freezing various cell types, including stem cells, primary cells, cell lines, and yeast, etc.
- "Slow freezing" to protect cell activity; just place in a -80°C freezer to make the sample cool down 1°C per minute.
- Zero addition and zero emissions, permanent use, and responds to the call of environmental protection.

Cell Freezing Box

Product number	Shap	Specifications (mm)	Application
200101	Hexagonal	S108X100 (S: Side Length)	Holds 1 mL/2 mL cryogenic tubes or microcentrifuge tubes(12-φ13)
200102	Square	117X117X100	

Automation Tips

● Brand T Automation Tips



Automation Conductive Tips for Brand T



Compatible with Brand T Systems

Brand T Automation Tips:

50 / 200 / 1000 µL

(Available in various packagings with or without filters)

Brand H Automation Tips:

50 / 300 / 1000 µL

(Available in various packagings with or without filters)

Compatible with Brand B Systems: 190 / 250 µL

(Available in various packagings with or without filters)

● Brand H Automation Tips



Automation Conductive Tips for Brand H

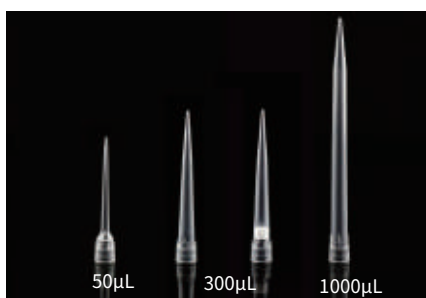

Compatible with Brand H Systems

● Compatible with Brand B Systems



Compatible with Brand B Systems

● Advantages

- Medical-grade black conductive polypropylene (PP) materials.
- Electron beam sterilization: Safe and fast, without chemical residue.
- Uniform conductivity: Tips of the same box sharing the same cavity number ensures the product traceability and the conductivity uniformity and improves the accuracy of experimental results, greatly reducing the difference among each tip.
- The smooth inner surfaces of tips supported by the unique processing technology greatly reduces the amount of residual liquid.
- The porous filtration of filter tip ensures optimum performance. And the super hydrophobicity of the tip forms a strong barrier against aerosols thus eliminates the risk of cross-contamination among samples.
- **Strong package:** The package of thickened high-strength blister card is resistant to impact and dropping, which ensures the integrity and safety of the product under harsh transport conditions.
- **Good air tightness and adaptability:** The structure mapping is conducted as per the original adapter and the proven injection-molding ensures that the products have good air tightness and adaptability, improving the mechanical precision of the products during work.
- **Strict quality management and control test:** Class 100,000 clean workshop, effective quality inspections are conducted under strict quality management including tests for DNA, RNA, proteases, and pyrogens, satisfying clients' needs.
- Air tightness test: Precise equipment is used to test the air tightness between the tip and the adapter, to ensure good air tightness for each batch of products.
- Tests for resistance and CV values: A certain number of products are sampled for each batch for inspection, which is conducted by precise and unique measuring tools for accuracy and reliability of the test results to ensure the uniform conductivity of products.

● Adaptation model

- Brand T automation conductive tips may be used with the TECAN Freedom EVOlyzers and fully automatic sampling systems.
- Brand H automation conductive tips are used in conjunction with Hamilton series workstations.
- Brand B robotic tips are used in Beckman FX/NX, Biomek i5/ i7 and Biomek 3000.

● Brand T Automation Tips

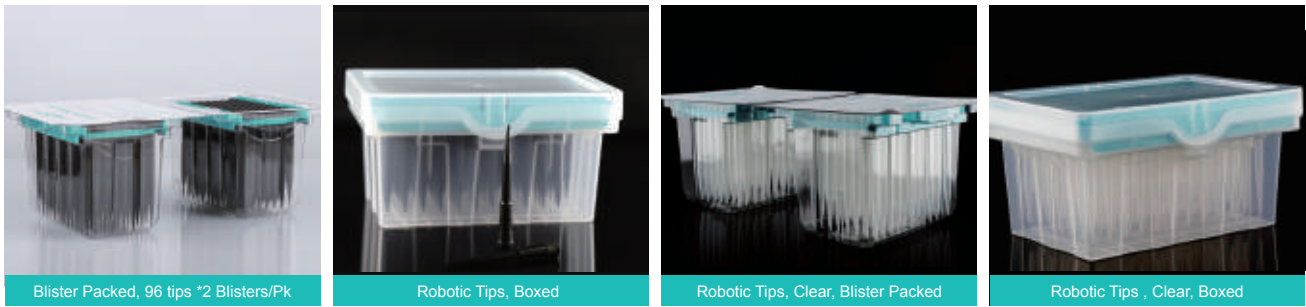

Volume (µL)	Packing			Automation Conductive Tips		Robotic Tip	
	Specification	/Pack	/Case	No Filter	Filter	No Filter	Filter
50	Blister Packed (96 Tips*2)	96	24	332002	332012	332003	332013
	Boxed	96	50	/	332016	332007	332017
200	Blister Packed (96 Tips*2)	96	24	332102	332112	332103	332113
	Boxed	96	50	/	332116	332107	332117
1000	Blister Packed (96 Tips*2)	96	24	332202	332212	332203	332213
	Boxed	96	50	/	332216	332207	332217

● Brand H Automation Tips

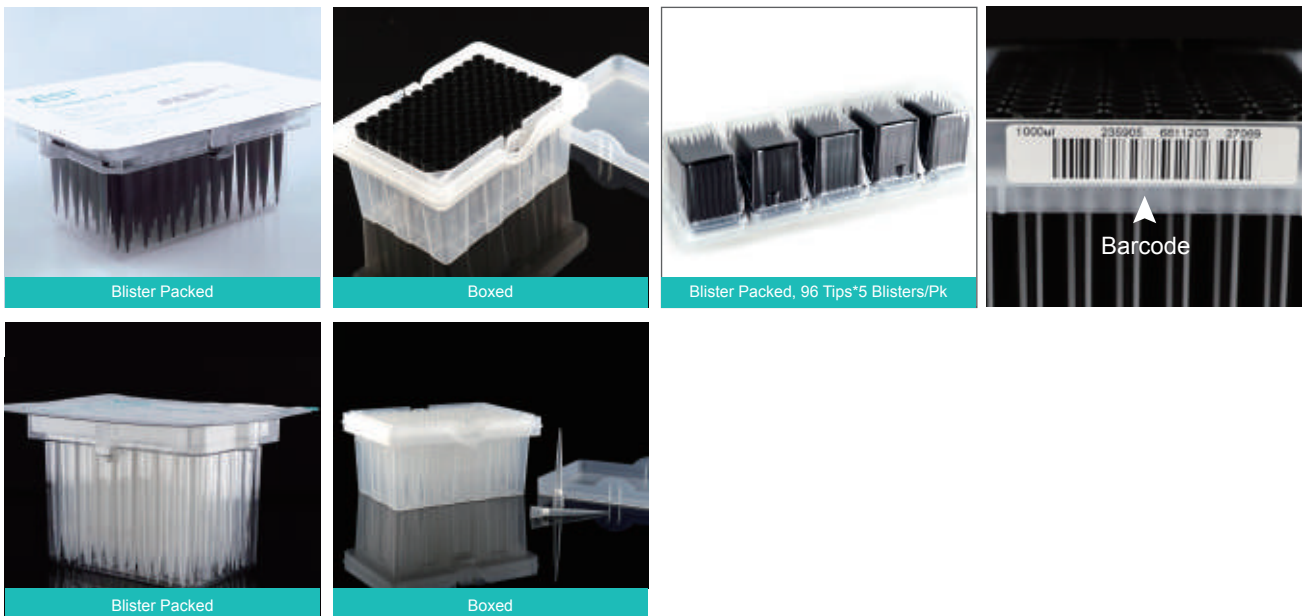

Volume (µL)	Packing		Automation Conductive Tips		Robotic Tip	
	Specification	Packaging	No Filter	Filter	No Filter	Filter
50	Blister Packed	96 pcs/rk 24 rks/pk	345002	345012	/	/
	With Barcode, 96 Tips*5 Blisters/Pk	96 pcs/rk 60 rks/pk	345005	345015	/	/
	With Barcode, 96 Tips/Pk	96 pcs/rk 24 rks/pk	/	345013	345503	345513
	Boxed, With Barcode	96 pcs/box, 10 boxes/pk, 5 pks/cs	/	345069	345509	345519
300	Blister Packed	96 pcs/rk 24 rks/pk	345102	345112	/	/
	With Barcode, 96 Tips*5 Blisters/Pk	96 pcs/rk 60 rks/pk	345105	345115	/	/
	With Barcode, 96 Tips/Pk	96 pcs/rk 24 rks/pk	/	345113	345603	345613
	Boxed, With Barcode	96 pcs/box, 10 boxes/pk, 5 pks/cs	/	345169	345609	345619
1000	Blister Packed	96 pcs/rk 24 rks/pk	345202	345212	/	/
	With Barcode, 96 Tips*5 Blisters/Pk	96 pcs/rk 60 rks/pk	345205	345215	/	/
	With Barcode, 96 Tips/Pk	96 pcs/rk 24 rks/pk	/	345213	345703	345713
	Boxed, With Barcode	96 pcs/box, 10 boxes/pk, 5 pks/cs	/	345269	345709	345719

● Brand B Automation Tips

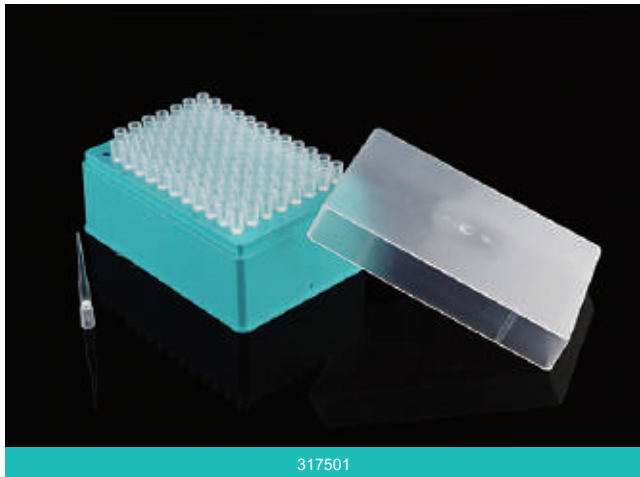

317501

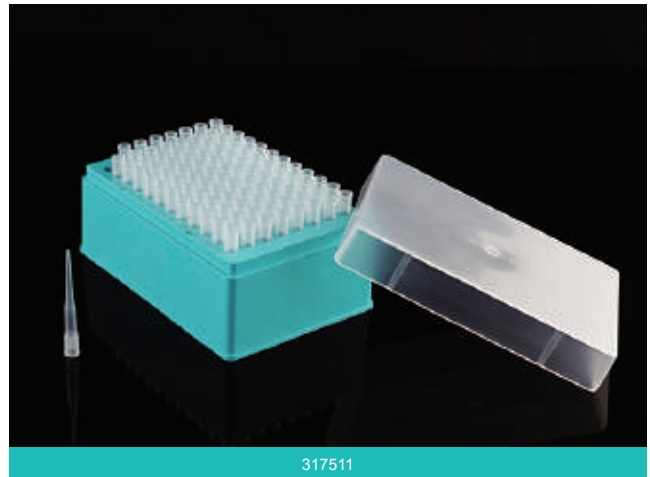

317511

Volume (µL)	Filter	Sterilization	/Pack	/Bag	/Case	Cat.No.
250	NO	YES	96	10	5	317511
190	YES	YES	96	10	5	317501

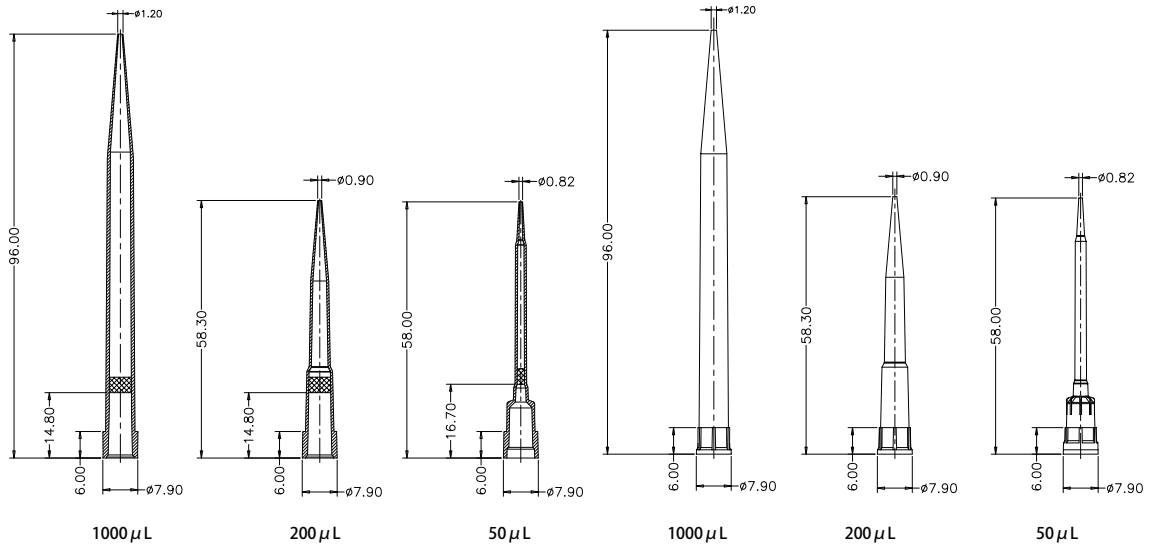

Brand T Automation Tips

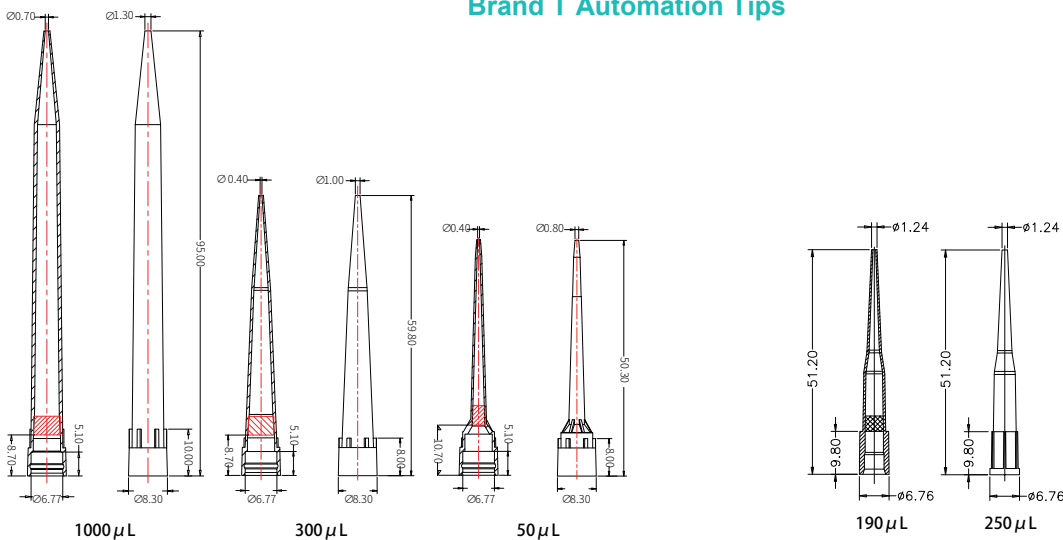

Brand H Automation Tips

Brand B Automation Tips

Stackable Tip Refill

• Features

- NEST Refill Pipette Tips, Bulk are more convenient for customers to use, saving work and shortening work time, and improving work efficiency.
- NEST Refill Pipette Tips, Bulk are used for quantitative transfer of liquid consumables. They are used in experimental fields with liquid transfer operations, such as in biology and chemistry, and for liquid transfer in cell culture laboratories, liquid addition, liquid suction, or other liquid transfer uses.

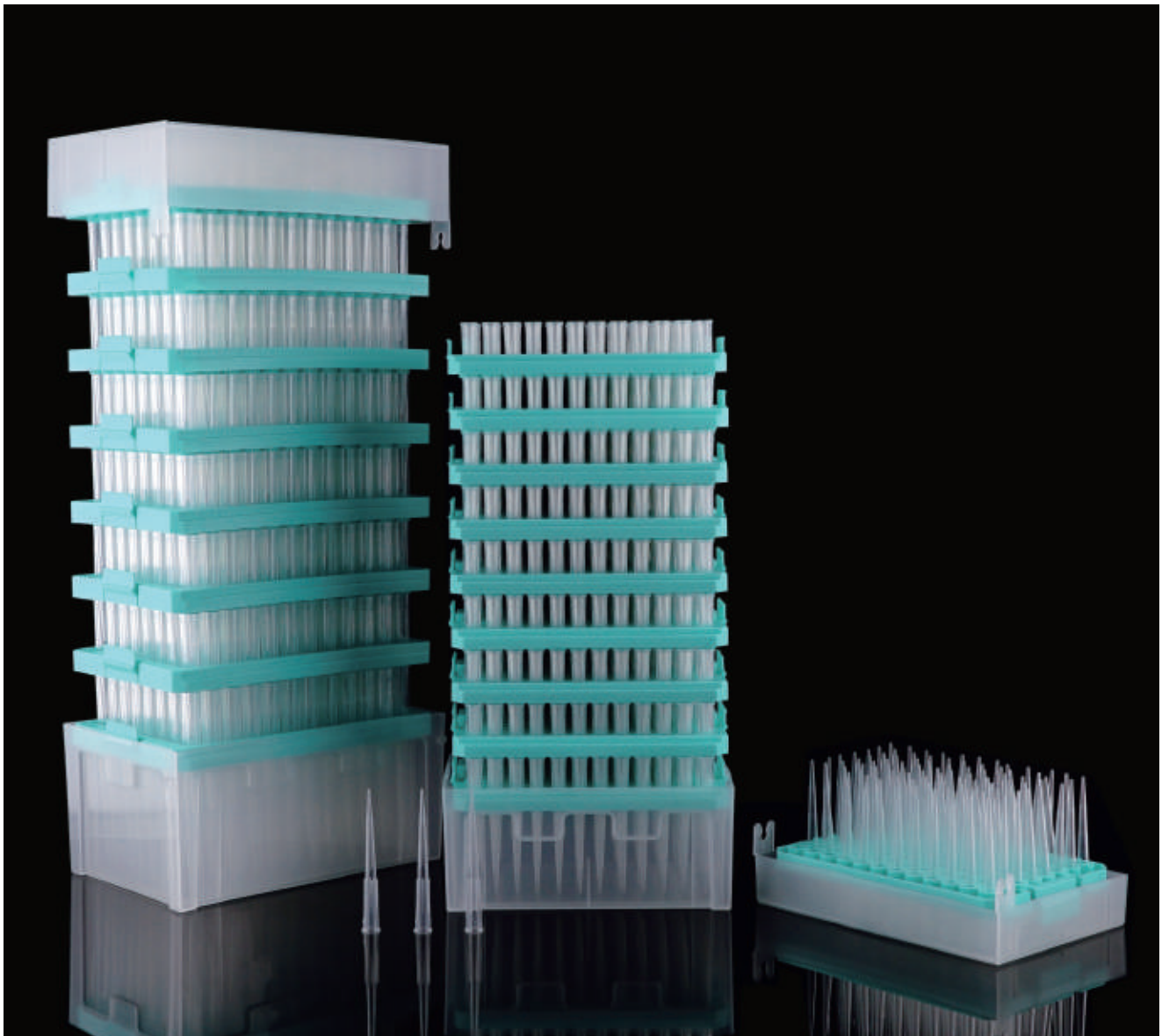

● Product Introduction

The stacked tips are assembled by stacking 5-10 different-sized tips into the tip box holder. They are convenient for customers to use, reduce costs, and have a high utilization rate. Only one box bottom is needed, and when one box is used up, another one can be loaded into the box holder.

● Product Usage and Application Direction

- Product usage: more convenient than bagged pipette tips and more economical than single-box packaging, improving work efficiency and saving work time.
- Application direction: genomics, proteomics, cytology, immunodetection, metabolomics, biopharmaceutical research and development, and other commonly used high-throughput liquid transfer uses.

● Product features

- Experimental-grade polypropylene (PP) is used for all injection-molded parts of the product.
- The whole set of products is assembled by stacking 5-10 pieces, which is convenient for customers to use.

● Instructions for Use

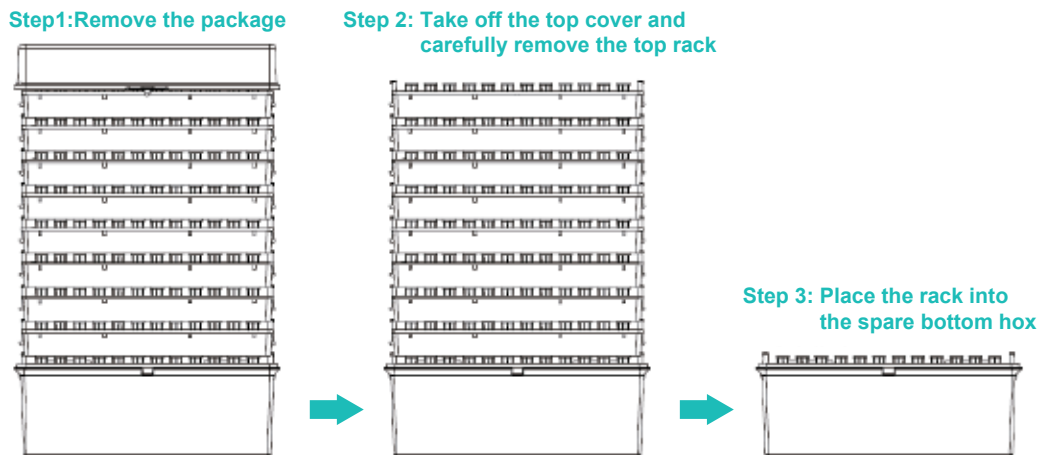

● Product specifications

Technical Drawings				
Cat.No.	301081	302081	305081	303081
Volume (µL)	10 µL	200 µL	300 µL	1000 µL
Packing	96/Pack 10 Pack/Box 10 Box/Case		96/Pack 5 Pack/Box 10 Box/Case	
Filter	NO	NO	NO	NO
Sterilization	NO	NO	NO	NO

Pipette Tips

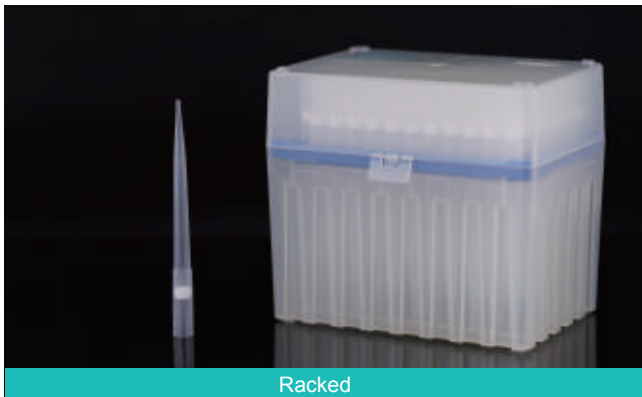
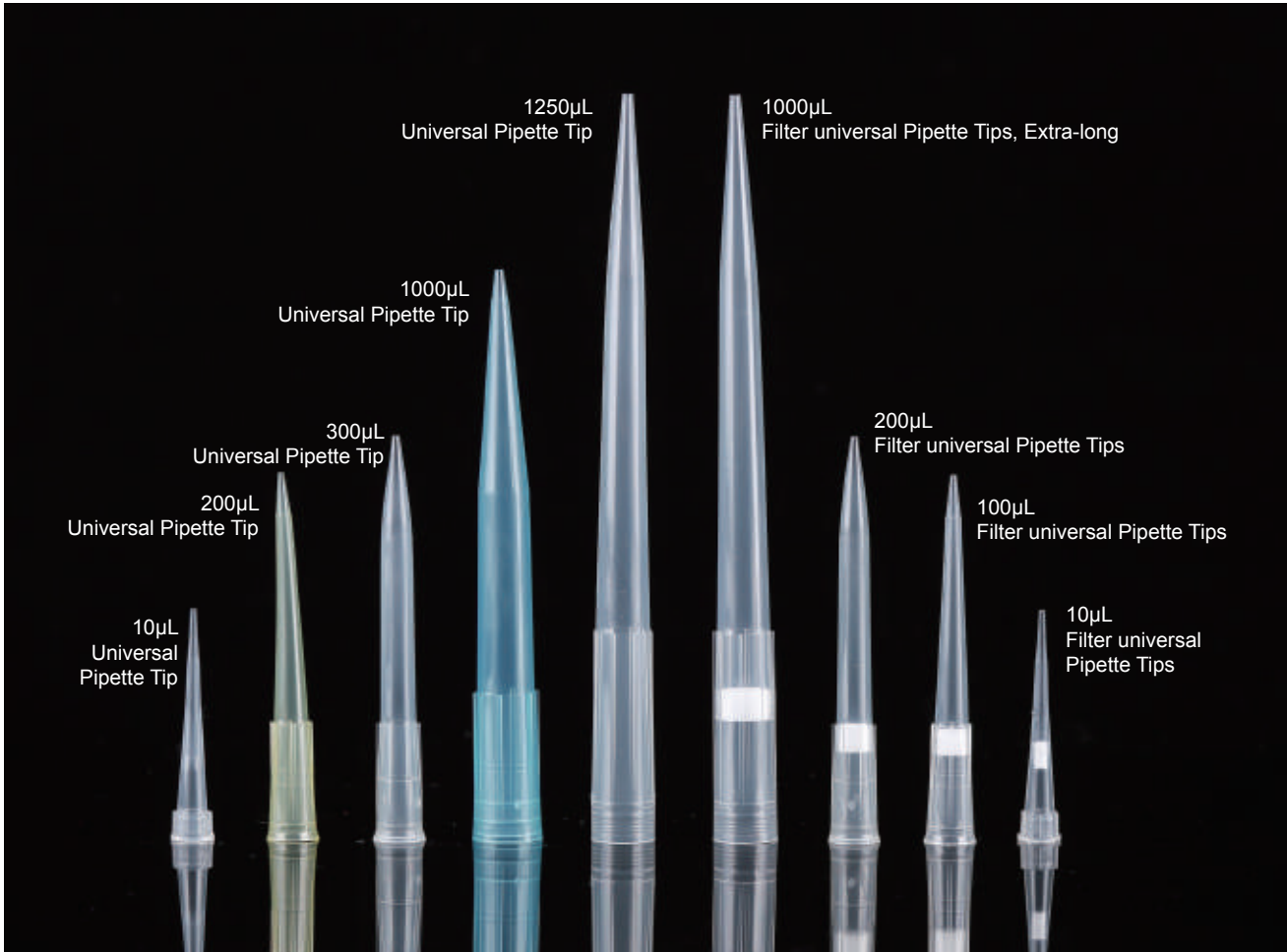

Feature

- Standard size: suitable for major pipettes on the market.
- Smooth interior: minimizes residue and ensures accurate pipetting.
- High-quality materials: the imported PP materials is in line with USP Class VI.
- High-quality filter: pure UHMW polyethylene through unique processing technology.
- Super hydrophobicity: hydrophobic filter forms a solid barrier to aerosols, eliminating the risk of cross-contamination between sample and pipette.
- Optimal pore size: ensures smooth aspiration
- Advanced technology: ultra-fine grinding and moulding technique without mould release agent ensures better product quality.
- Innovative design: ensures good flexibility, sealing and compatibility.
- Standard workshop: Class 100,000 cleanroom to ensure the products are free of pyrogen and DNase/RNase.
- Transparency: good transparency make it easy to observe the liquid level during use.
- Resistant to organic solvents: used to pipette various organic solvents.
- Individual labelling: each package has a Cat. NO for quality tracking and traceability.
- Highly efficient sterilization- Larger effective membrane filtration area of 4.9 cm².
- High flow rate and throughput.

● Pipette Tip Bulk, Non-Sterile

Volume (µL)	Universal Pipette Tips				Filter Universal Pipette Tips			
	Colour	/Pack	/Case	Cat.No.	Colour	/Pack	/Case	Cat.No.
10	Clear	1000	20	301006	Clear	1000	10	311001
10 (Extra-long)	Clear	1000	10	314001	Clear	/	/	/
100	/	/	/	/	Clear	1000	10	316001
200	Yellow	1000	20	302106	Clear	1000	10	312001
300	Clear	1000	10	305006	Clear	/	/	/
1000	Blue	1000	5	303206	Clear	1000	5	313006
1000 (Extra-long)	/	/	/	/	Clear	500	10	313001
1250	Clear	500	10	304006	/	/	/	/

● Pipette Tip Racked, Sterile

Volume (µL)	Universal Pipette Tips					Filter Universal Pipette Tips				
	Colour	/Box	/Pack	/Case	Cat.No.	Colour	/Box	/Pack	/Case	Cat.No.
10	Clear	96	10	5	301016	Clear	96	10	5	311012
10 (Extra-long)	/	/	/	/	/	Clear	96	10	5	314016
20	/	/	/	/	/	Clear	96	10	5	310012
100	/	/	/	/	/	Clear	96	10	5	316012
200	Yellow	96	10	5	302116	Clear	96	10	5	312012
300	Clear	96	10	5	305016	/	/	/	/	/
1000	Blue	100	10	5	303216	Clear	96	10	5	313016
1000 (Extra-long)	/	/	/	/	/	Clear	96	10	5	313012
1250	Clear	96	10	5	304016	/	/	/	/	/

● Tip Box, Box without tips

Volume (µL)		Middle panel holes	Packing	Cat.No.
Universal Tip Box	Filter Tip Box			
10	/	96	50 pcs/cs (Box only)	351001
200	20/100	96	50 pcs/cs (Box only)	351101
300	200	96	50 pcs/cs (Box only)	351401
1000	1000	100	50 pcs/cs (Box only)	351201
1250	1250	96	50 pcs/cs (Box only)	351301



Vacuum Filtration System

NEST Disposable Vacuum Filtration System is useful for large volume sample separation and sterilization of tissue culture media and other biological buffers. The units include PES or PVDF membrane filters with graduated filter tops made with polystyrene, and acrylonitrile-butadiene-styrene necks with polystyrene receiving bottles. A separated sterile polyethylene cap is included. Filtration system is manufactured from raw material of high transparency polystyrene (PS) in three different volumes: 250 mL / 500 mL / 1000 mL. They are available in three styles: complete filter/storage bottle systems, bottle top filters, and receiving bottles only.



● Features

- High flow rates and flux.
- Low protein binding and low chemical extractability.
- Pore size: 0.22 µm.
- Non-Pyrogenic, DNase/Rnase free.
- Sterilized by E-beam, SAL=10⁻⁶.
- Individually packaged in sterile bag.
- No endotoxin, no pyrogen.
- For laboratory use only.
- If the package is damaged, please do not use.

Membrane Type	Hydrophilicity	Features	Application Directions	Cautions
PES	Hydrophilic	Low protein adsorption, high flow rate, wide PH range, high chemical compatibility, good heat resistance.	For general culture media and aqueous solutions, polar or middle-polar solvents, neutral aqueous solutions.	Not applicable for chloroform, esters, amides and strong acids or strong bases.
PVDF	Hydrophilic	Wide practicability, good oxidation resistance and heat resistance.	May be used for aqueous solutions and most solvents, including strong non-polar solvents. Ideal for preparations of HPLC and GC.	Not applicable for strong acids and bases.
MCE	Hydrophilic	Strong chemical compatibility and low protein adsorption, the optimum pH range is 3-6.	Used for particle analysis of general culture media and aqueous solutions. HPLC sample preparation.	The set should not be used for filtration of ethanol and alkaline solutions. The working temperature should not be over 40°C.
CA	Hydrophilic	High flow rate and heat stability as well as very low adsorption, stable within the range of pH 4-8.	It may resist most alcohols and oils, and is suitable for sterling filtration of aqueous solutions, buffers, serum and culture media, as well as filtration of the moving phase of HPLCD.	The CA membrane may accommodate a smaller volume of buffer since it has low hydrophilia.

Comparison of the flow rate of different brands of vacuum filters

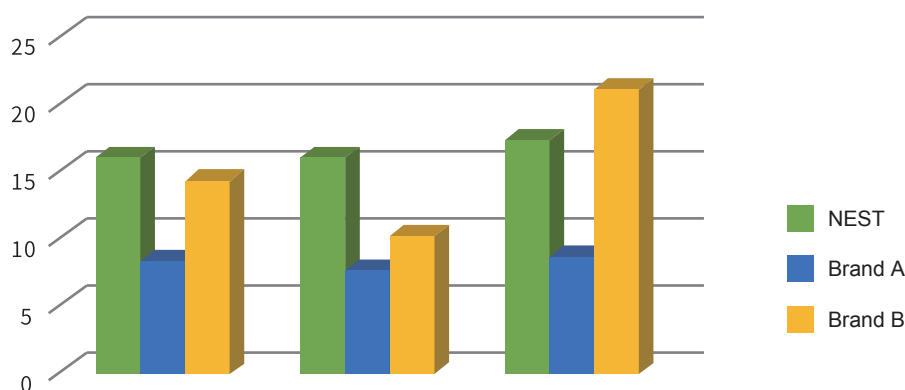

	DMEM+10%FBs	RPMI1640+10%FBs	TSB
■ NEST	16	16	17.39
■ Brand A	8.33	7.69	8.7
■ Brand B	14.29	10.26	21.1

Product Parameters

Volume (mL)	Membrane Dia(mm)	Capacity(mL)	Max.Temp (°C)	Neck Dia(mm)	Height (mm)	Material of Neck
250	50	250	45	45	198	ABS
500	90	500	45	45	247	ABS
1000	90	1000	45	45	280	ABS

● Vacuum Filtration System

Volume (μL)	Pore Density (μm)	Vacuum Filtration Systems (Sterile) 1/Pack, 12/Case		Bottle Top Vacuum Filter (Sterile) 1/Pack, 24/Case	
		PES Membrane	PVDF Membrane	PES Membrane	PVDF Membrane
50	0.10	347002	347102	347012	347112
	0.22	347001	347101	347011	347111
	0.45	347003	347103	347013	347113
150	0.10	346002	346102	346012	346112
	0.22	346001	346101	346011	346111
	0.45	346003	346103	346013	346113
250	0.10	342002	342102	342012	342112
	0.22	342001	342101	342011	342111
	0.45	342003	342103	342013	342113
500	0.10	343002	343102	343012	343112
	0.22	343001	343101	343011	343111
	0.45	343003	343103	343013	343113
1000	0.10	344002	344102	344012	344112
	0.22	344001	344101	344011	344111
	0.45	344003	344103	344013	344113

● Polystyrene Storage Bottles (Sterile)

Volume (μL)	Size (mm)			Packing		Cat.No.
	Height	Bottleneck Diameter	Bottom Diameter	/Pack	/Case	
150	80	42	89.15	1	24	346021
250	105		88	1	24	342021
500	145		96	1	24	343021
1000	178.5		122	1	12	344021

Warning

- Do not use plastic bottles, glass bottles, flasks or containers that are not designed for filtration and cannot withstand negative pressure to connect to the upper cup .
- Not suitable for culture flasks larger than 2L.
- Working temperature: 4-37°C.
- Working pressure: 0.03-0.06Mpa, if there is foam, please reduce pressure appropriately.
- Tighten the upper cup and bottle mouth by hand, but do not over tighten.
- Personal protective equipment must be used at all times, and goggles must be worn when using vacuum equipment.
- Work on the aseptic operating table.
- It is not recommended to recycle any hazardous substances, hazardous substances, wastes or biochemically hazardous materials.

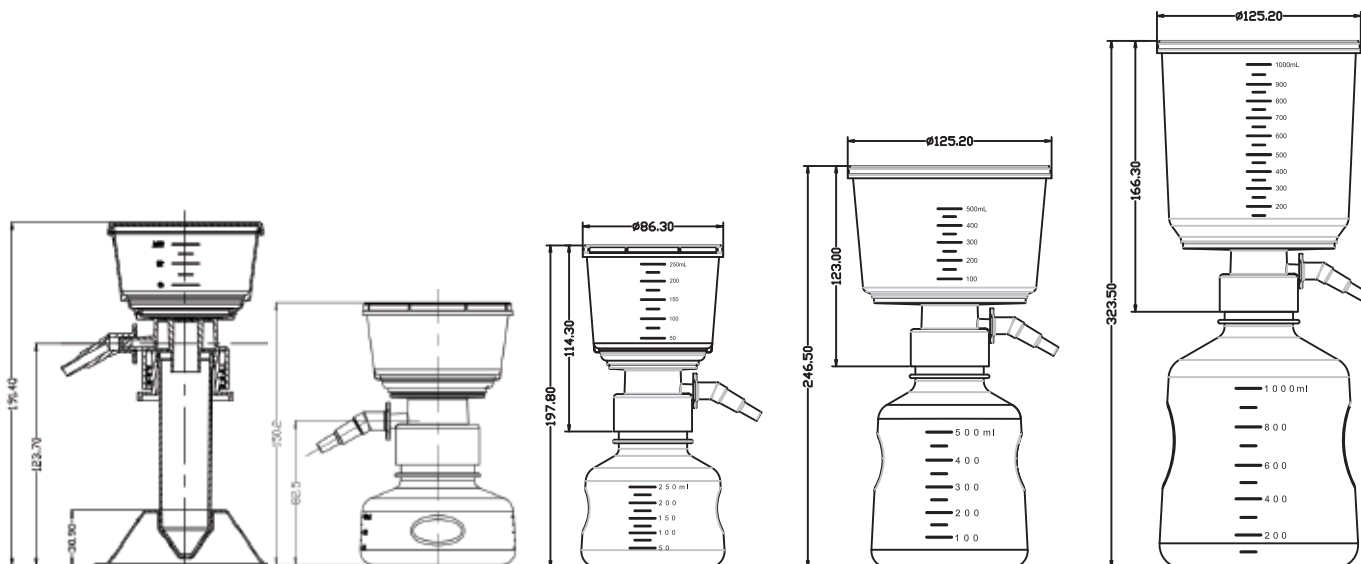

Syringe Filter

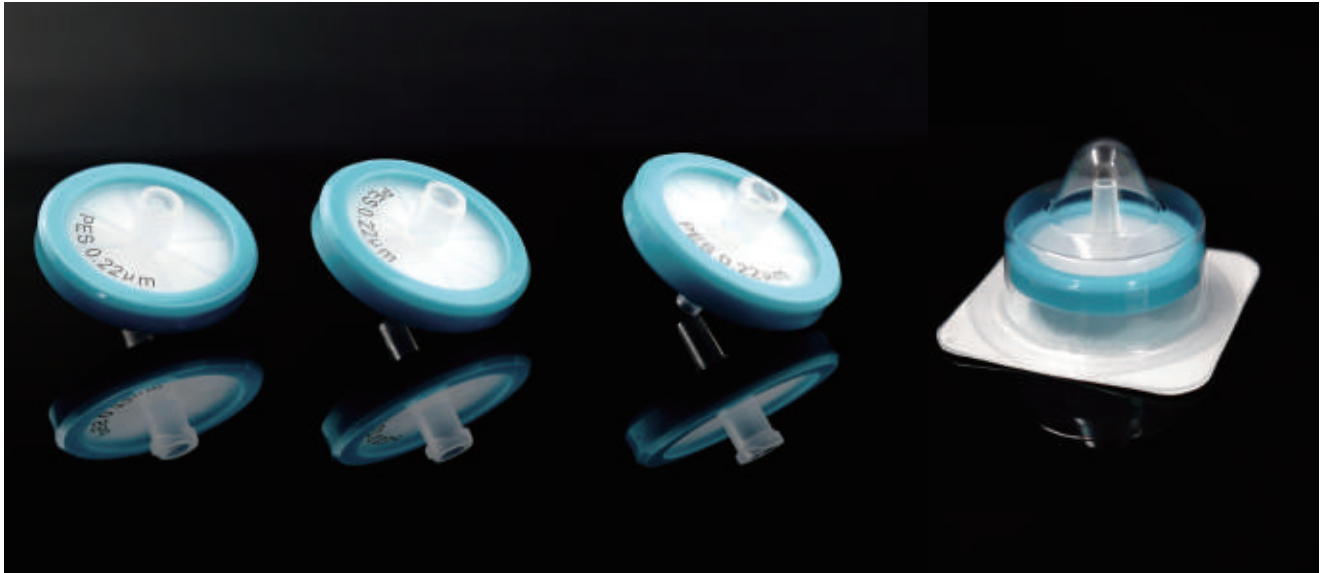

Syringe filters are used in fields like life sciences, pharmaceuticals, environment, biotechnology, food and beverages, agricultural testing laboratories, etc. In particular, they are widely used in life science laboratories to sterilize samples of small volume, such as proteins, additives, buffers, reagents and drugs. The one-piece injection molded package of syringe filters is made of medical polypropylene, which is resistant to high pressure and product leakage.

● Features

- Highly efficient sterilization
- Larger effective membrane filtration area of 4.9 cm².
- High flow rate and throughput.
- Sterilized by E-beam, SAL=10⁻⁶.
- Non-Pyrogenic, DNase/Rnase free.

Size (mm)	Pore Size (µm)	Membrane	Packing		Cat. No.
			/Pack	/Case	
30	0.22	PES	100	10	331011
30	0.22	PVDF	100	10	331001

● Precautions

- When handling chromatography samples, avoid introducing other impurities during the filtration process.
- Do not use a syringe with a volume less than 10 cc, which may cause excessive pressure in the injection tube thus resulting in membrane damage or personal injury.
- Single use only.
- Discard the initial few filtrates, of which the volume is about the volume of the filter.

Microcentrifuge Tube

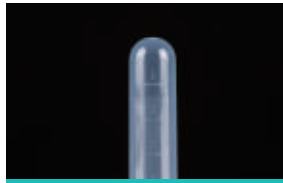

• Rounded bottom without tip



Special safe-lock cap



Clear graduations



Frosted marking area



- USP VI grade polypropylene material, free from heavy metal.
- Sterilized by E-beam, SAL=10⁻⁶.
- RNase free, endotoxin level less than 0.1EU.
- Each package is individually labelled with a Cat.NO for easy quality tracking and traceability.
- Brown colour provides protection from light, especially for light-sensitive substances.
- RCF: 30,000 xg.
- Autoclavable at 121°C/15psi

Volume (mL)	Bottom	Color	Sterile	/Pack	/Bag	/Case	Cat.No.
0.6	Round	Clear	Non-sterile	1000	/	10	605001
		Clear	Sterile	50	15	10	605601
		Amber	Sterile	50	15	10	605401
		Amber	Non-sterile	50	15	10	605501
1.5	Round	Clear	Non-sterile	500	/	10	615001
		Clear	Sterile	50	8	10	615601
		Amber	Sterile	50	8	10	615401
2.0	Conical	Clear	Non-sterile	500	/	10	620011
		Clear	Sterile	50	8	10	620611
5.0	Conical	Clear	Non-sterile	200	1	10	603011
		Clear	Sterile	200	1	10	603111

Micro Tube Box

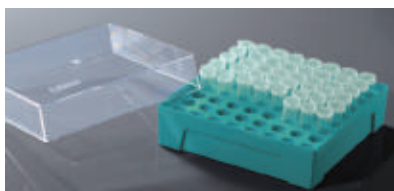

- Withstand temperature ranging from -80°C to 121°C.
- Solid polypropylene base and polycarbonate cover.
- Non-sterile.

Application (mL)	Spec (well)	/Pack	/Case	Cat.No.
0.6	10*10	5	8	613001
1.5/2	8*8	5	8	613111

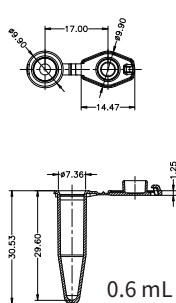

0.6 mL

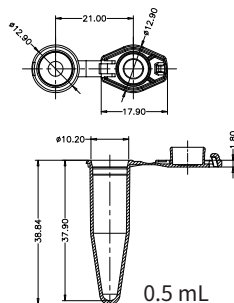

0.5 mL

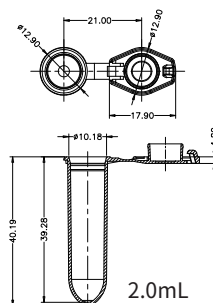

2.0 mL

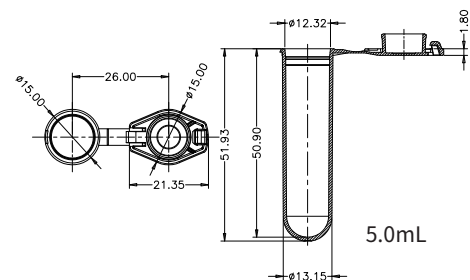

5.0 mL

15/50 mL Centrifuge Tube

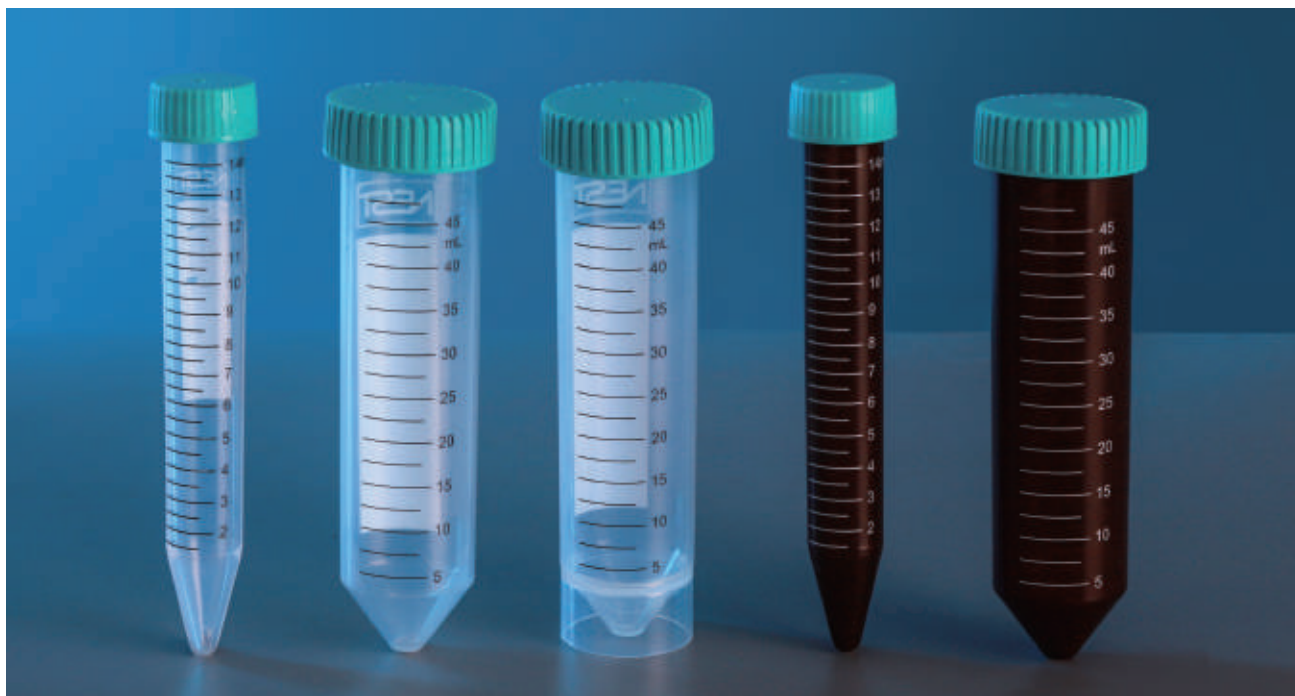

PS Rack



Bulk



Centrifuge Tube Rack

● Features

- Printed Graduations (with marking area).
- Polypropylene tube and high-density polyethylene cap.
- High centrifugal strength up to 12,000xg.
- Flat markable cap with leakproof seal.
- One-hand operation design for the caps is easy to handle.
- Sterilized by E-beam, SAL=10⁻⁶.
- Non-Pyrogenic, DNase/Rnase free.

● Premium Level

- Up to the standards of biological analysis.
- High strength non-toxic materials.
- Raw material comply with USP VI complies.

● Centrifuge Tube Rack

- Made of virgin polypropylene.
- Reusable and economic.
- Non-sterilized.

Application	/Case	Cat.No.
For 15 mL Tubes	50	610001
For 50 mL Tubes	50	610101

Volume (mL)	Color	Packaging	Max.RCF(xg)	Sterile	Packing		Cat.No.	
					/Pack	/Case	Premium Level	Standard Level
15	Clear	PS Rack	12000	Yes	50	10	601001	601051
	Clear	Bulk	12000		50	10	601002	601052
	Amber	PS Rack	12000		50	10	601201	/
50	Clear	PS Rack	12000		25	20	602001	602051
	Clear	Bulk	12000		25	20	602002	602052
	Amber	PS Rack	12000		25	20	602201	/
	Clear	Bulk	5000		25	20	/	602072
50 (Self-Standing)	Clear	Bulk	5000					

Peripheral Blood Lymphocyte Separation Tube

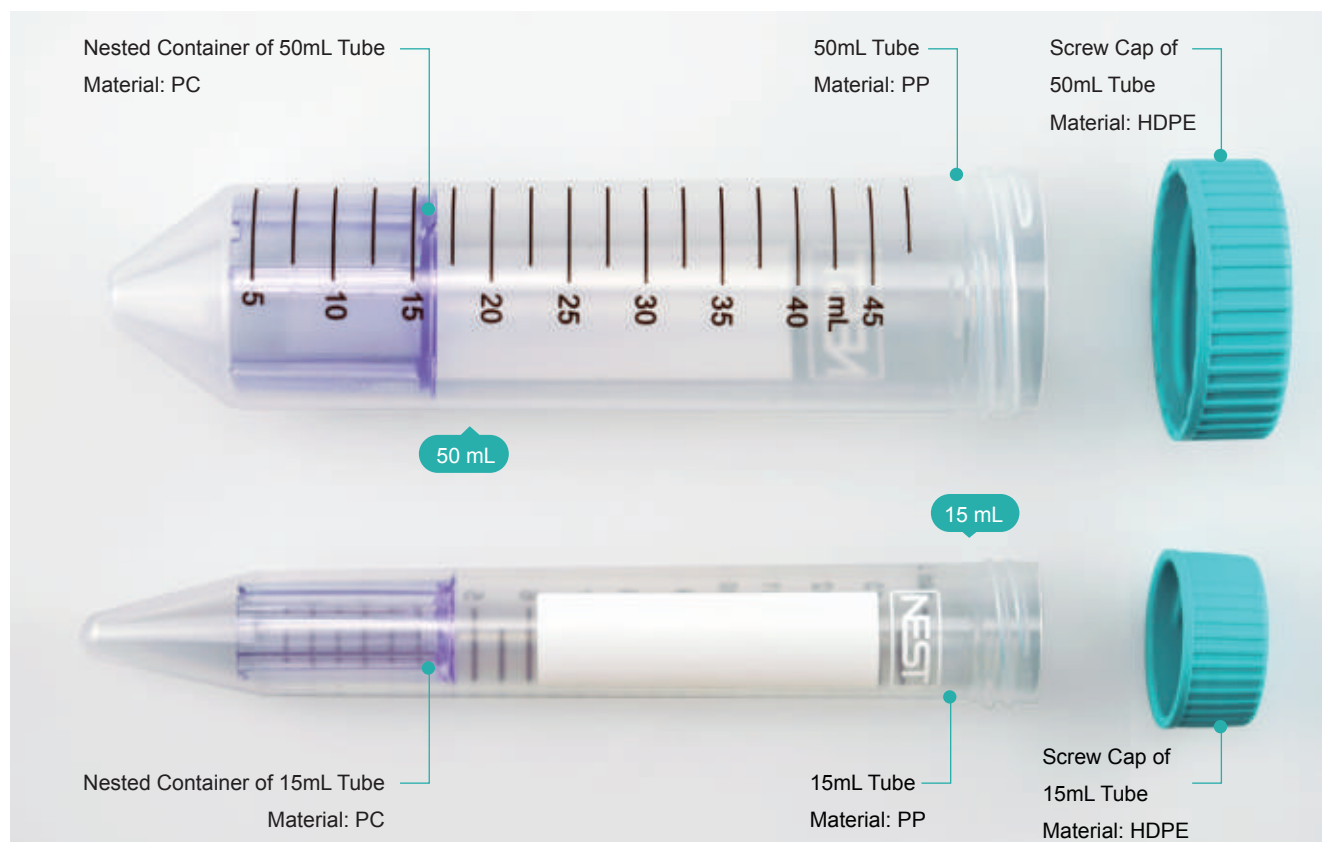

This product separates and purifies cells with separation solution by means of density gradient centrifugation according to the difference in cell density. With the density gradients generated inside, the target cells can be retained on top of the nested container in the tube, which is designed specifically to separate the target sample from the density gradient medium to the utmost extent; while erythrocytes and granulocytes will sink at the bottom after centrifugation, and the PBMC (Peripheral Blood Mononuclear Cell, including lymphocytes and monocytes, etc.) will float on the surface. Only the simple operation of decanting is involved in the final stage, and no other professionally technical operations required.

● Features

- Rapid separation and purification for PBMC within only 15 min.
- Simple operation procedures: no need to slowly and laboriously add samples into the solution; when collecting samples, simply decant the centrifuge tube. No other professionally technical operations are required.
- Good reproducibility for reduced errors and less operation variation among users.
- E-beam sterilized with SAL=10⁶.
- No heat source; no nucleases.

● Usages and Application Directions

Peripheral Blood Lymphocyte Separation Tube is mainly applied to separate Peripheral Blood Mononuclear Cell (lymphocytes and monocytes) from whole blood or bone marrow through density gradient centrifugation. For research use only.

Volume (mL)	Capacity(mL)	Sterile	Packing		Cat.No.
			/Pack	/Case	
15	4-9	Yes	50	10	601852
			50	3	601851
50	13-30		25	20	602852
			25	4	602851

● Instructions

Preliminary Preparation

- Cool off the separation solution away from light to the room temperature (RT) .
- Add the separation solution by a serological pipette through the central hole of the nested container: for a 15 mL tube, add approximately 4 mL separation solution; for a 50 mL tube, add approximately 13 mL separation solution; Please ensure the separation solution on top of the nested container throughout the procedure.
- Add the drawn anticoagulated blood and bone marrow into the separation tube cooled off to the room temperature. Besides, adding saline to dilute the specimen is not requisite but can help improve the separation result.

Separation

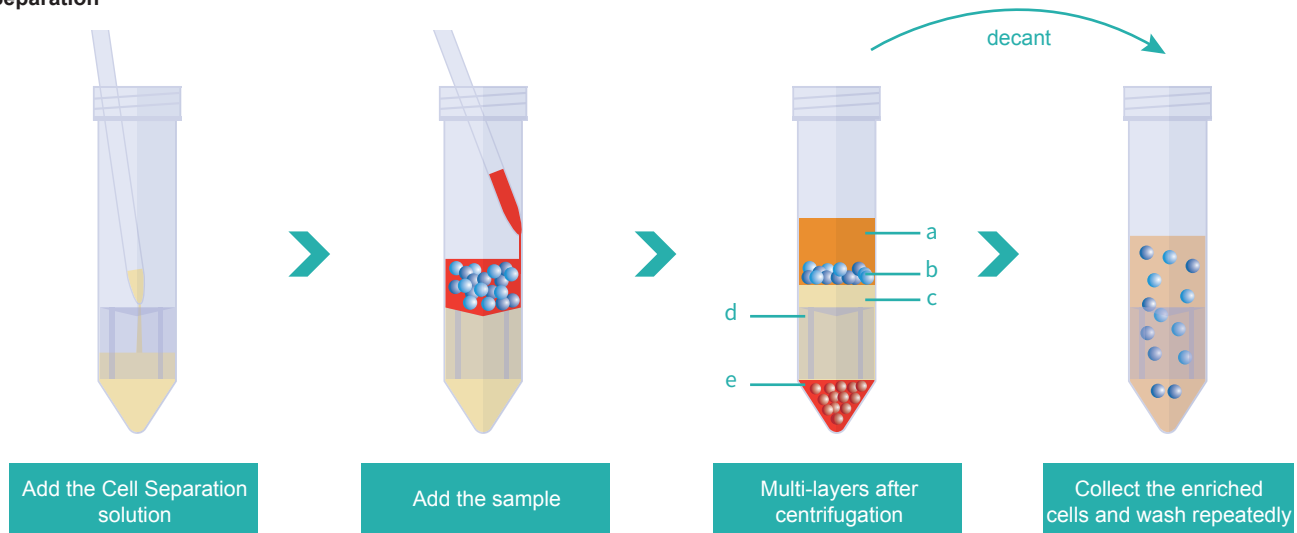

- Slowly pour or pipette the anticoagulated sample (blood or bone marrow, diluted with saline if needed) along the tube wall into the tube slowly: for a 15 mL separation tube, 4-9 mL of the sample is recommended; for a 50 mL separation tube, 13-30 mL of the sample is recommended.
- Centrifuge at room temperature with a centrifugal force of 1200 x g for 10 minutes, then turn off the centrifuge. For samples left for more than 24h, longer centrifugation time is recommended.
- Liquid separation condition after centrifugation (from top to bottom): A. plasma; B. enriched cell fractions (intermediate phase contains lymphocytes/PBMCs cells); C. separation solution; D. nested container; E. precipitation (erythrocytes and granulocytes). Collect or directly discard the plasma layer of 5-10 mm above the enriched cells to prevent the enriched cells from re-contamination by platelets.
- Collect the enriched cells (lymphocytes/PBMCs cells) and pour the supernatant from the separation tube into another clean centrifuge tube, during which the nested container works to prevent the enriched cells from re-contamination by erythrocytes and granulocytes. Don't invert the separation tube for more than 2s.
- Wash the enriched cells (lymphocytes/PBMCs cells) with Phosphate Buffer Solution(PBS) then centrifuge them at 250 xg for 10 min.
- Repeat the washing 2 times as in step 5 and finally re-suspend cells with 5 mL PBS.

● Precautions

- This product should be operated by professionally trained personnel under the guidance of good laboratory practices.
- Do not re-use the separation tube.
- Specific separation effects may vary due to the difference in centrifuges' performance from different brands and the difference in regional temperature and environment. Users may adjust the speed and time of centrifugation to find out the best separation conditions (up to respective laboratory).
- The product is applicable to the sample of human peripheral blood, bone marrow and umbilical cord blood, but not to leukocyte isolation samples, samples with brownish yellow layer of erythrocyte sedimentation nor samples over 48 hours.
- After centrifugation, cells may aggregate on the tube wall above the enriched layer, which is a normal phenomenon influenced by the quality, sample placement time and anticoagulant type of sample, but independent of the use of the separation tube. Cells can be removed by scraping the interior wall with a pipette tip.
- When specimens of any biological origin are involved, operate the blood taking needles, blood collection tubes and related instruments, etc. cautiously in accordance with strict protocols. Do treat specimens as hidden dangerous sources of infectious diseases such as HIV, HBV, HCV, etc, in which case disposable gloves are necessary in order to avoid the risk of infection during operation.

250/500 mL Centrifuge Tube



500 mL Racked



250 mL Racked

The 250 mL & 500 mL centrifuge tubes can process a large number of samples at one time and are suitable for the separation and harvest of large amounts of cells, supernatants, bacteria, yeast and tissue samples. Therefore, they are widely used in the field of life sciences and clinical.

● Application

- Separation of sediments after chemical reactions for harvest and application.
- Harvest of biomacromolecules, inorganics and organics.
- In biochemistry and other biological fields, usually used to centrifuge and collect a large volume of cells, biomacromolecules and supernatants.

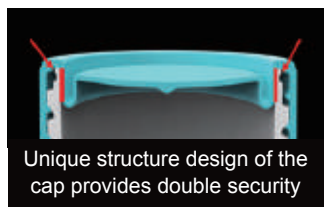

Unique structure design of the cap provides double security



Newly added o-ring

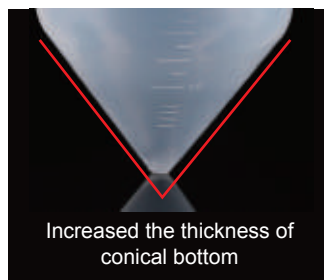

Increased the thickness of conical bottom

● Features

- Unique structure design of the cap provides double security, further improving the tight seal ability.
- Increased the thickness of conical bottom in order to improve the maximum centrifugal limit.
- Polypropylene tube and high density polyethylene cap.
- Max. centrifugal limit 7000xg.
- Temperature range: -80 °C~120 °C.
- Clear scale.
- DNase, RNase and pyrogen free.
- Electron beam sterilization, SAL=10⁻⁶.
- Separation of sediments after chemical reactions for harvest and application.
- Harvest of biomacromolecules, inorganics and organics.
- In biochemistry and other biological fields, usually used to centrifuge and collect a large volume of cells, biomacromolecules and supernatants.

Packaging	Sterile	Volume (mL)	/Pack	/Case	Cat.No.
Bulk	Yes	250	6	102	622001
Bulk	Yes	500	6	36	623001
Racked	Yes	250	6	24	622002
Racked	Yes	500	4	24	623002

Centrifuge Tube Closed System Solution



● Product Description

The pre-assembled Closed System of Centrifuge Tube is convenient for aseptic sampling and transfer during biological production procedures. Each is double-packed and equipped with a seal cap which can be used to substitute the pipes in case of subsequent centrifugation and analysis.

The pre-assembled Closed System of Centrifuge Tube is convenient for customers in biomedical/biopharmaceutical/vaccine production industries to aseptically sample and transfer the tissue and cell culture/ vaccine solutions, which can effectively save the assembling and sampling time and lower the cost.

● Features

- The pre-assembled Closed System is ready to use at hand. The closed liquid transfer avoids the contamination risk of open transfer and eliminates the necessity of subsequent cleaning validation.
- The pipeline material meets the requirements of industrial pharmaceutical enterprises, and is connected to male taper at the connector, which prevents accidental disconnection and offers convenience.
- The double aseptic packaging suits GMP production.
- Pipelines can be customized according to demand.

Volume (mL)	Tube Material			0.2μm Filter Membrane area	/Case	Cat.No.
	Dia.	Length	Connector			
50		50 cm	Male Luer Connector	4.5cm ²	4	C60622-EFB050A
250					4	C60922-EFB050A
500					4	C61022-EFB050A

Pasteur Pipette

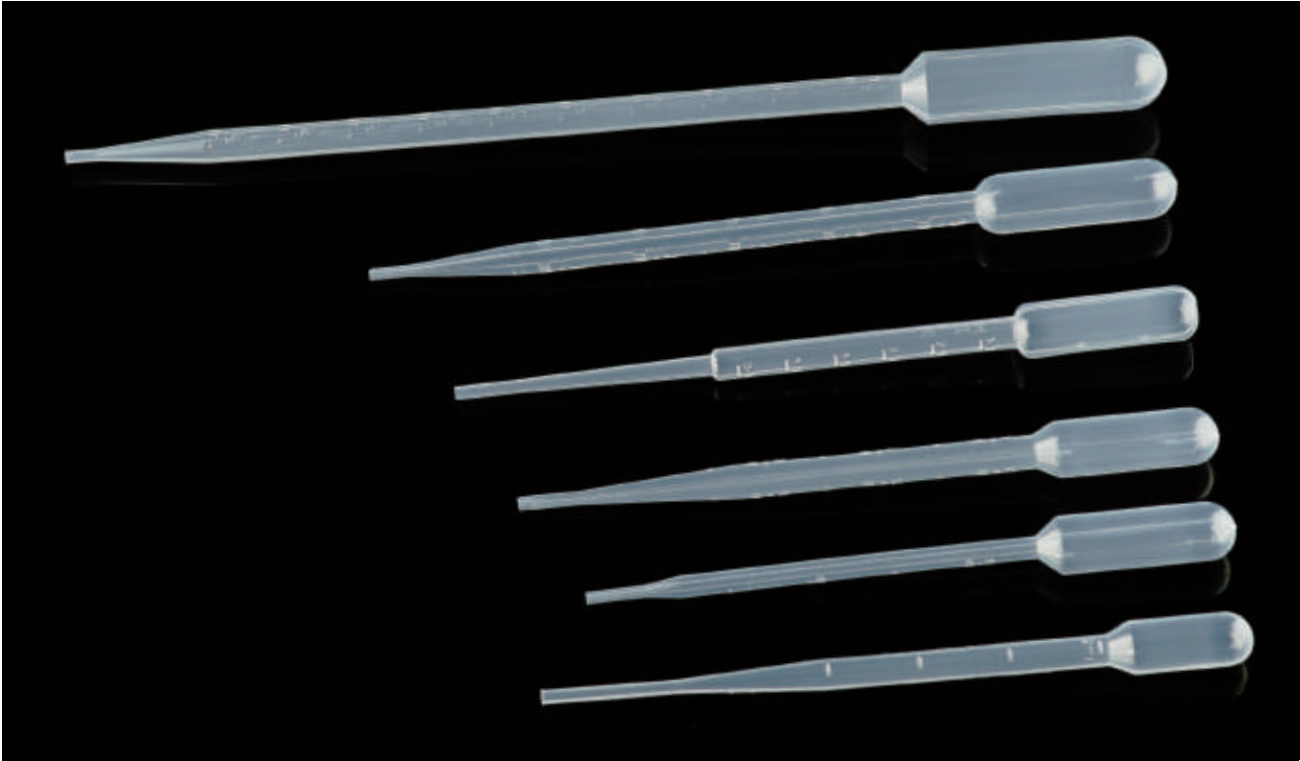

• Features

- Good chemical stability.
- Transparent with clear graduations for easy observation.
- Pipette can be twisted for use with micro vessels and special-shaped containers.
- Good resilience for rapid liquid transfer
- High precision and good repeatability.
- Each package is individually labelled with the batch number for easy quality tracking and traceability.
- DNase/RNase, endotoxin and pyrogenic free.
- Individually wrapped, sterilized by EO, SAL=10⁻⁶.

Volume (mL)	Length (mm)	Packaging	Sterile	Packing		Cat.No.
				/Pack	/Case	
1	144	Individually Packed	Sterile	4	500	318012
		Bulk	Non-sterile	10	500	318031
2	150	Individually Packed	Sterile	4	500	318112
		Bulk	Non-sterile	10	500	318131
3	162	Individually Packed	Sterile	4	500	318212
		Bulk	Non-sterile	10	500	318231
	182 (Extra Long)	Individually Packed	Sterile	10	200	318314
5	200	Individually Packed	Sterile	4	250	318516
10	285	Individually Packed	Sterile	4	125	318417

Serological Pipette



Individually Plastic-plastic Wrapped



Individually Paper-plastic Wrapped

NEST serological pipettes can be used in biological research such as tissue culture and bacterial culture. They are made of highly transparent polystyrene and are individually packaged in paper-plastic bags. Pipettes of different specifications are distinguished by different colors.

• Features

- Edged color-coded band for identification.
- Made of high clarity, 100% virgin polystyrene.
- Negative graduations for extra volume.
- Polyolefin fiber filter to reduce contamination.
- Each package is individually labelled with the batch number for easy quality tracking and traceability.
- Non-Pyrogenic, DNase/Rnase free.
- Sterilized by E-beam, SAL=10⁻⁶.

Volume (mL)	Sterile	Packaging	/Box	/Case	Cat.No.
1	Yes	Individually Plastic-plastic Wrapped	500	6	324003
	Yes	Individually Plastic-plastic Wrapped	500	6	324001
2	Yes	Individually Plastic-plastic Wrapped	400	6	325003
	Yes	Individually Plastic-plastic Wrapped	400	6	325001
5	Yes	Individually Plastic-plastic Wrapped	200	4	326003
	Yes	Individually Plastic-plastic Wrapped	200	4	326001
10	Yes	Individually Plastic-plastic Wrapped	200	4	327003
	Yes	Individually Paper-plastic Wrapped	200	4	327001
10 (Ink-free laser printed)	Yes	Individually Paper-plastic Wrapped	50	10	327303
25	Yes	Individually Paper-plastic Wrapped	200	4	328003
	Yes	Individually Paper-plastic Wrapped	200	4	328001
50	Yes	Individually Paper-plastic Wrapped	100	6	329003
	Yes	Individually Paper-plastic Wrapped	100	6	329001
100	Yes	Individually Paper-plastic Wrapped	50	6	329501

Reagent Reservoir



• Features

- Made of USP Class VI compliant polypropylene.
- The V shape bottom is compatible with single or multi-channel pipettes during cell culture, immunoassays, etc.
- A large capacity of 60 ml; injection-moulded with scale lines
- Individually labelled with the Cat.NO for easy quality tracking and traceability.
- Non-Pyrogenic, DNase/Rnase free.

Volume (mL)	Sterile	Cap	/Pack	/Case	Cat.No.
60	No	Yes	5	25	360002
60	Yes	Yes	5	25	360012

Reservoir



8 Channel



12 Channel



96 Channel



384 Channel

• Features

- Perfectly overcomes the surface tension of liquids during automated pipetting and minimizes liquid residues.
- Made of USP Class VI compliant polypropylene, and is chemically stable and resistant to chemical corrosion.
- Freezable down to -80° C
- Less residue and wall hangings
- Conforms to ANSI (American National Standards Institute) SBS standards.
- Each package is individually labelled with the batch number for easy quality tracking and traceability.
- Non-Pyrogenic, DNase/Rnase free. Low heavy metal content.
- Sterilized by E-beam, SAL=10⁻⁶.

Channel Troughs	Volume (mL)	/Pack	/Case	Cat.No.	
				Non-sterile	Sterile
8	22	5	10	360101	360111
12	14	5	10	360102	360112
96	195	5	10	360103	360113
384	185	5	10	360104	360114

Round Storage Bottle



Round Storage Bottle is sterile and made from enzyme-free plastic in line with product packaging and storage requirements in molecular biology and cell biology, laboratory medicine, genomics and proteomics, etc. Improvement in the quality of product packaging helps to improve the company image and brand value, make our products' packaging comply with international standards and enter the international market.

● Features

- The raw materials, premium polypropylene (PP)/polyethylene (HDPE), are excellent in physical and chemical index and resistant to pressure, impact and acid-base. PP materials can undergo autoclave sterilization at 121 °C ; HDPE can be stored at -80 °C .
- A full range of choices to meet different packaging and storage requirements.
- The properties of wash-free and ready to use mean no need for tedious pre-cleaning processing work. The internal packaging is thickened to ensure transportation and storage safety.
- The professional leak-proof design of bottle mouth guarantees excellent seal ability and exempts the need for inner cover or inner gasket for protection.
- 100% leaking-proof guarantee ensures safety even during air transportation; wide-mouthed design makes it easy to access liquid inside.

No biotoxicity, pyrogen-free, DNase/RNase-free, manufactured in Class 100,000 clean workshop. The plastic bottles are sterilized using by GAMMA-ray.

Introduction of imported digital-controlled production equipment with high precision. The products are fine in details and comfortable to hold, with high uniformity among batches. The walls have high gloss but no color difference.

High-class molding technologies and surface processing technologies produce smooth interior and exterior surfaces of the plastic bottles without wicking effect of reagents during the process, subsequently significantly reducing sample wastage. With paralleled quality, our products can perfectly replace the imported competitors.

● Application

- NEST Round Storage Bottle is designed for liquid storage in molecular and cellular biology, laboratory medicine, genomics and proteomics research.

Volume (mL)	Size(mm)			Packing		Polypropylene (PP)		Polypropylene (PP)	
	Bottleneck Diameter	Bottom Diameter	Height	/Pack	/Case	Material	Cat.No.	Material	Cat.No.
8	13.8	24.8	42.3	20	20	HDPE	335101	PP	335201
15	13.8	24.8	56.1	20	20	HDPE	336101	PP	336201
30	21	33.9	59.05	10	20	HDPE	337101	PP	337201
60	21	38.6	81.5	10	20	HDPE	338101	PP	338201
125	28	50.8	95.5	10	10	HDPE	339101	PP	339201
250	33	60.5	127.6	10	10	HDPE	340101	PP	340201
500	43.8	73	161.6	5	10	HDPE	341101	PP	341201

Sample Vial



● Application

- Caps have 6 color Caps (blue, red, yellow, purple and natural) personalize the identification of different reagents in a fast and convenient way.
- Cap color is encoded in the product code.
- Products are made of transparent polypropylene (PP) which meets USP Class VI standards and is free of heavy metal ions. Products can be used in proteomics, drug development, genomics and other fields.
- Special knurling design on the vial body enables the vial to be stuck in the special base and to be tightened with a single hand.
- Silicone O-ring inside the screw caps ensures secure sealing. ADR & IATA compliant, no liquid leakage in negative pressure test under a pressure of -0.95 bar.
- Withstands a maximum centrifugal force up to 20,000 xg.

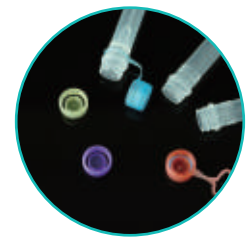

Available in 6 colors

● Sample Vial

Volume (mL)	Packing		Bottom	Cat.No.
	/Pack	/Case		
0.5	500	4	Self Standing	633901
1.5	500	4	Self Standing	634901
1.5	500	4	Self Standing	634911
2.0	500	4	Conical	635901

● Sample Vial Cap

Color	Packing		External Thread Cap	External Thread Cap Hinged Cap
	/Pack	/Case		
Blue	500	4	633951B	633961B
Red	500	4	633951R	633961R
Yellow	500	4	633951Y	633961Y
Purple	500	4	633951P	633961P
Natural	500	4	633951N	633961N
Green	500	4	633951G	633961G

Cluster tube

NEST 1.1mL 96-well Cluster Tube Box conforms to the ANSI-SBS standard and is compatible with multi-channel pipettes and automated liquid workstations. The raw material of tube body is imported PP, which meets the USP-CLASS 6 standard. It has high transparency and good chemical stability, and is suitable for low-temperature storage of cells, drugs, tissues, sera, and other reagents.

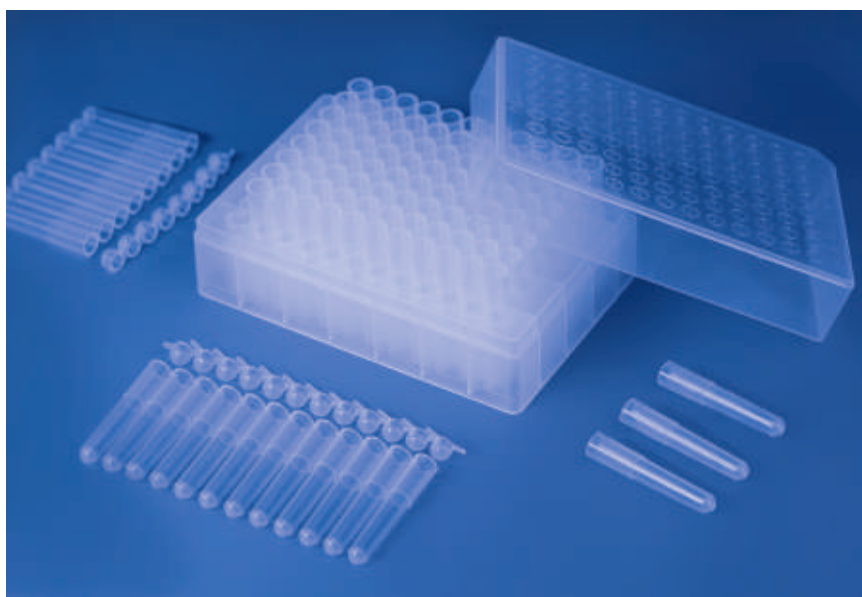

Complete Specifications

- NEST 1.1mL Cluster Tubes are available in single tube, 8-strip, and 12-strip, and the tube caps are available in 8-strip and 12-strip for customers to choose from.
- They are compatible with multi-channel pipettes and automated liquid workstations with SBS standard size carriers.

Exquisite Design

- The one-way cap design, with letter and number grids, ensures positive identification of samples.
- The bottom and side walls of the box holder are hollowed out for good thermal conductivity, and the box supports direct immersion in a water bath.

High Quality Raw Materials

- The raw material is imported PP, which conforms to USP class 6 standards. The 8-strip and 12-strip caps are made of TPE, which has better sealing performance.
- Resistant to low temperature storage at -80°C , and autoclavable.

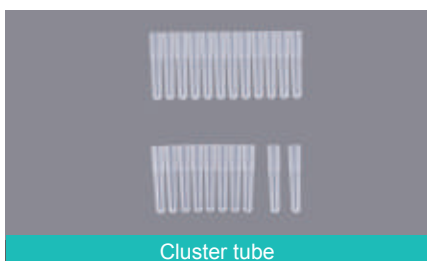

Cluster tube



Boxed Cluster Tube



Bagged Cluster Tube Cap

Cluster Tube

Schematic Diagram	Name	Packaging			Material	Sterile Cat.No.	Non-sterile Cat.No.
	1.1mL Single Cluster Tube	Bagged	960 pcs/bag	5 bags/case	PP	/	628111
		Boxed	96 pcs/box 10 boxes/pack	5 bags/case	PP	628114	628112
	1.1mL 8-strip Cluster Tube	Bagged	120 pcs/bag	5 bags/case	PP	/	628121
		Boxed	12 pcs/box 10 boxes/pack	5 bags/case	PP	628124	628122
	1.1mL 12-strip Cluster Tube	Bagged	80 pcs/bag	5 bags/case	PP	/	628131
		Boxed	8 pcs/box 10 boxes/pack	5 bags/case	PP	628134	628132

Cluster Tube Cap

Schematic Diagram	Name	Packaging			Material	Sterile Cat.No.	Non-sterile Cat.No.
	8-strip Cluster Tube Cap	Bagged	120/bag	5 bags/case	TPE	628923	628921
	12-strip Cluster Tube Cap	Bagged	80/bag	5 bags/case	TPE	628933	628931

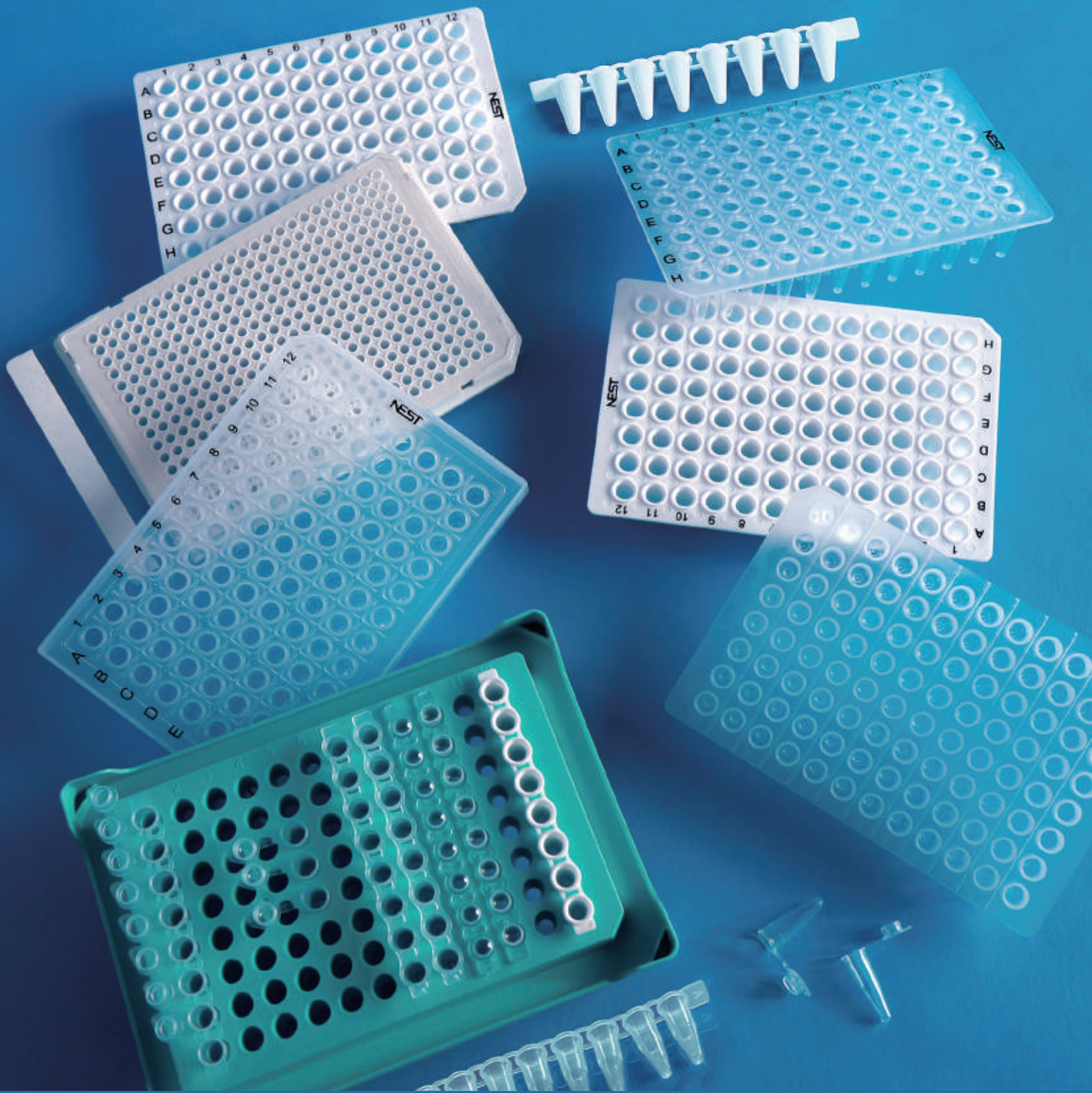

Molecular Biology

ELISA Plate

NEST ELISA plate, made of polystyrene, is a safe, reliable and effective supporter in enzyme-linked immuno-absorbent assay (ELISA). The features of the plates are crucial for the adsorption of antigens, antibodies and antigen-antibody complexes. ELISA plates from NEST adopts a unique surface treatment process, allowing to obtain ideal results in ELISA tests which are extensively employed in vitro diagnostics in medical and clinical laboratories.

● Features

- The plates are made of polystyrene and are designed specifically for ELISAs. They present good adsorption performance and low baseline value.
- Uniform thickness and size.
- High batch-to-batch stability and low coefficient of variation (CV) value.
- Both detachable and non-detachable flat-bottom plates are offered for customers to choose from based on their applications.
- The letters and numbers on the frame of the plates are convenient for detection and identification in experiments.
- High transparency of clear plate bottom.
- White plates are best suited for luminescence measurements as they reflect the signal instead of absorbing it and hence enhance the luminescence signals. Raw materials show good light-proof properties, which greatly reduce well-to-well signal interference.

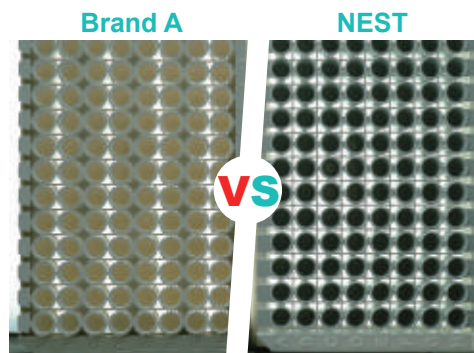

● Features of detachable 96-well ELISA plate

- Greatly improves the flexibility in diagnostic testing.
- Each well is locked in the frame, all at the same horizontal.
- The design of 8-well strip allows for uniform reading and washing.

White Elisa Plates is light-proof, and can lower the cross-talk between wells

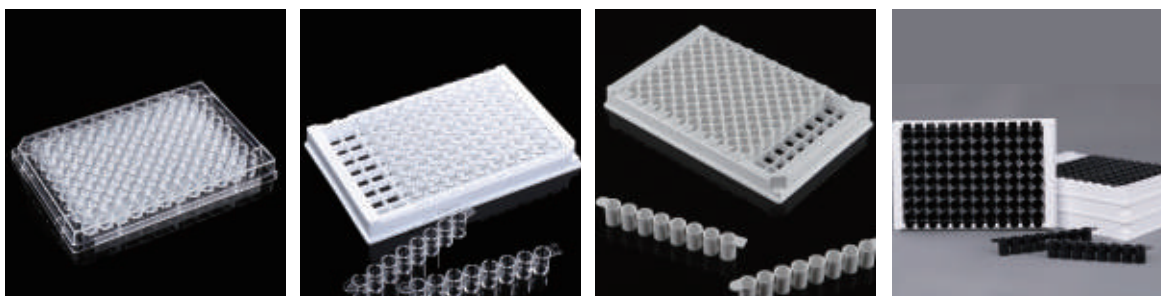

Cat.No.	514201	504201	504271	504261
Specification	F96	12 x F8	12 x F8	12 x F8
Color	Transparent	White Frame & Clear Well	White Frame & White Well	White Frame & Black Well
Description	Undetachable	Detachable	Detachable	Detachable
Packing	5/Pack 10 Pack/Box	5/Pack 10 Pack/Box	5/Pack 10 Pack/Box	5/Pack 10 Pack/Box
Features	High transparency		White Elisa Plates is light-proof, and can lower the cross-talk between wells	Made of non-autofluorescent materials with good protein adsorption and low background fluorescence.
Application	Quantitative and qualitative solid phase immunoassay and binding assay		Autofluorescence, chemiluminescence	Fluorescence immunoassay and binding assay

Deep Well Plate

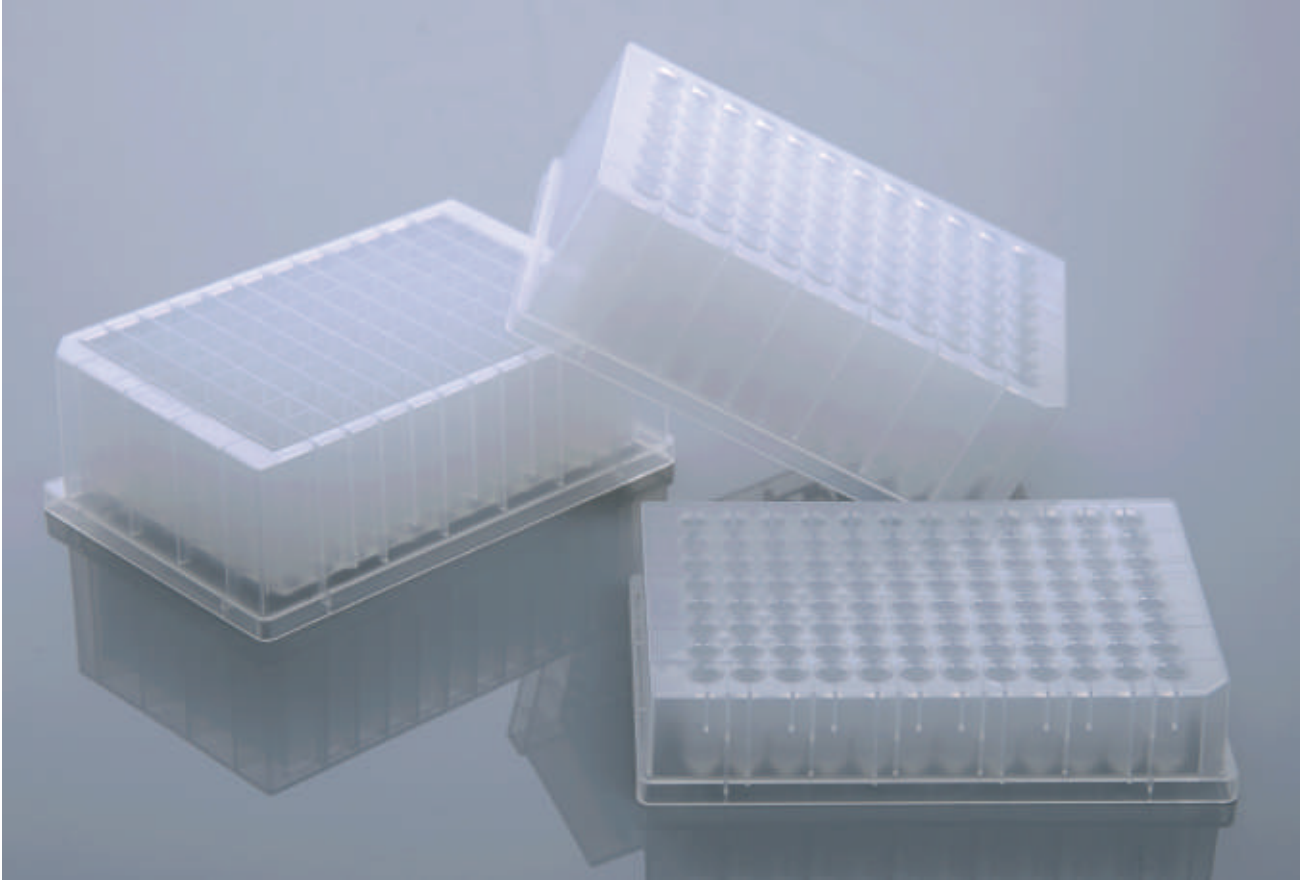

The length and width of the deep well plate comply with the SBS international standards. The deep well plates of NEST have a variety of specifications, conforming to the needs of fully automatic workstations and experiments.

● Features

- High quality imported PP material employed for high stability and no chemical reactions with test reagents.
- Compatible with DMSO and inert to water.
- Can be stored under subzero temperature from -40 to -80 °C.
- Maximum sustainable centrifuge force 4000g.
- Autoclavable at 20Psi, 121 °C for 20 minutes, great heating uniformity.
- Minimum residual liquid, low heavy metal content.
- Certified DNase/RNase and Pyrogen Free.
- Conformed to international SBS Standards.
- Good flat and can be transported for long distance if sealed by heat sealable film.
- Produced and packed in Class 100,000 clean workshop.
- Alphabetical sorting and corner cut marking for convenient tracking of samples.
- Each package has a separate article number/batch number identification, facilitating the quality tracking.

● Application

Genomic DNA extraction, plasmid DNA extraction, and purification of various samples. High-throughput automatic liquid operation to achieve high-throughput operations, such as protein precipitation, liquid extraction, and processing of animal tissues, bacteria, plants, soil, clinical samples, yeasts, etc.

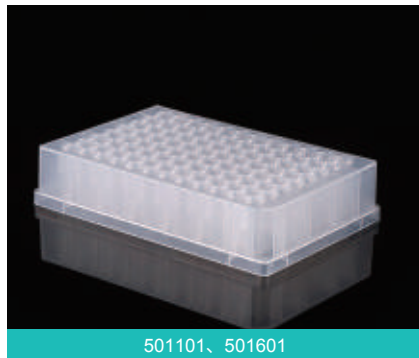

● Round Well

Specification	Volume (mL)	Bottom	/Pack	/Case	Non-sterile Cat.No.	Sterile Cat.No.
48-Round well	3.5	U-Bottom	10	5	504102	504162
96-Round well	0.36	V-Bottom	10	5	500101	500161
	0.4	U-Bottom	10	5	501102	501162
	0.5	V-Bottom	10	5	501101	501601
	1	U-Bottom	5	10	/	502162
	2	U-Bottom	5	10	503102	503162
	1.3	U-Bottom	5	10	507001	507101

● Plastic Tip Comb

Specification	Bottom	/Bag	/Pack	/Case	Non-sterile Cat.No.	Sterile Cat.No.
8 Tip Combs	U-Bottom	2	25	10	509211	509261
8 Tip Combs	V-Bottom	1	/	25		509001
MagPure 96 Tip Combs	V-Bottom	5	/	10	503311	503361

503361, 503311 Compatible with KingFisher Flex&Presto

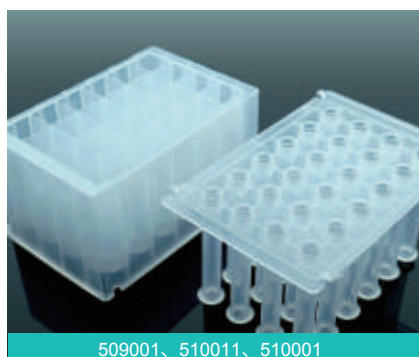

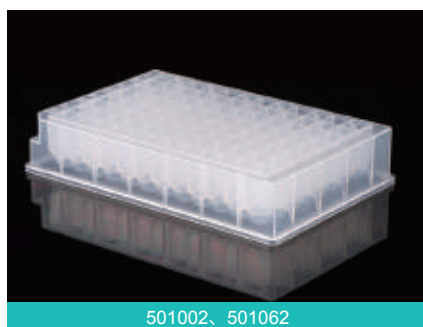

501002、501062



503001、503501



503002、503062



503021、503621



504002、504062

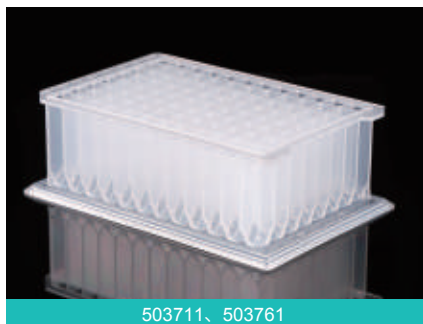

503711、503761

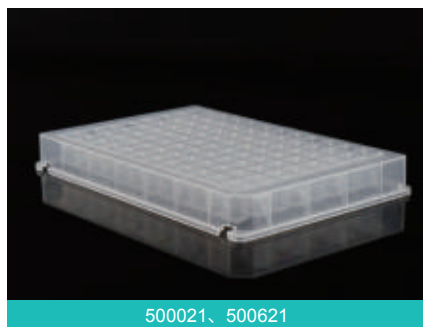

500021、500621

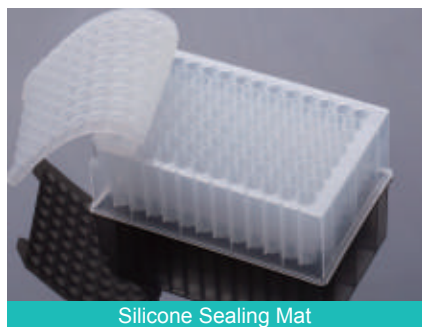

Silicone Sealing Mat

● Square Well

Specification	Volume (mL)	Bottom	/Pack	/Case	Non-sterile Cat.No.	Sterile Cat.No.
24 Square Well	16	V-Bottom	1	25	/	510001
24 Square Well with 24 Well Plastic Comb	16	V-Bottom	1	25	510071	510011
48 Square Well	4.6	U-Bottom	5	10	504062	504002
96 Square Well	0.5	V-Bottom	5	10	500021	500621
	1	U-Bottom	10	5	501002	501062
	1.6	U-Bottom	5	10	502002	502062
	2	V-Bottom	5	10	503001	503501
	2.2	U-Bottom	5	10	503002	503062
	2.2	V-Bottom	5	10	503021	503621
96 I Shape Square Wells	2.2	U-Bottom	5	10	503711	503761

500021、500621、503021、503621 Compatible with King Fisher Flex&Presto

● Silicone Sealing Mat

Compatibility	Volume	Piercibility	/Pack	/Case	Cat.No.
96 Well Round well	≤ 1.0 mL	Can be punctured	10	5	506005
	2.0 mL	Can be punctured	10	5	506006
96 Well Square well	0.5-2.2mL		10	5	506003
		Can be punctured	10	5	506004

8-Strip PCR Tube & Tube & Cap

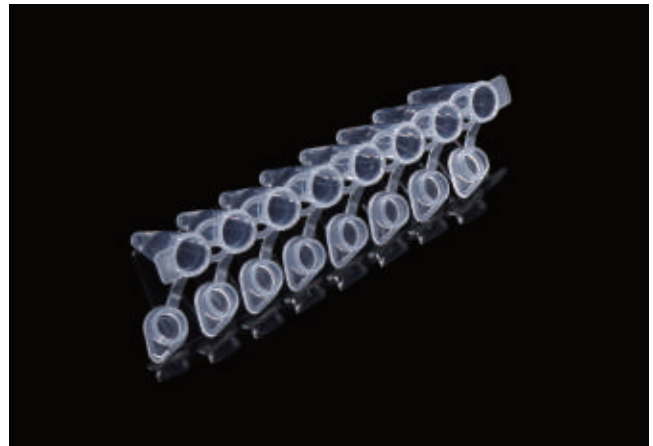

● PCR Tube

Volume (mL)	Cap Type	Color	/Pack	/Case	Cat.No.
0.2	Flat	Transparent	1000	10	401001

● Features

- Made of polypropylene.
- Compatible with all major PCR and real-time PCR instruments on the market. Thin-wall design produces high thermal conductivity, allowing the reaction solution inside to reach the target temperature as quickly as possible.
- The cap has excellent sealing performance and is easy to open; the loss of reaction volume can be controlled within 5% when a PCR heated lid is applied.
- A maximum capacity of 250 μ L.
- No human DNA, no DNase/RNase, no PCR inhibitors.
- Zip-lock bag.

● PCR 8-strip Tube with Individual Cap Attached

Volume (mL)	Cap Type	Color	/Pack	/Case	Cat.No.
0.2	Flat	Transparent	120	10	404001

● Features

- No human DNA, no DNase/RNase, no PCR inhibitors.
- Zip-lock bag.
- White PCR 8-strip tubes can effectively prevent signal interference, increase signal strength, and improve experimental efficiency.

● PCR 8-strip Tube

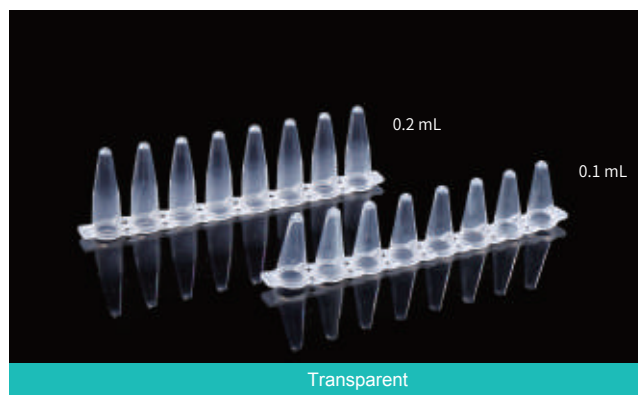
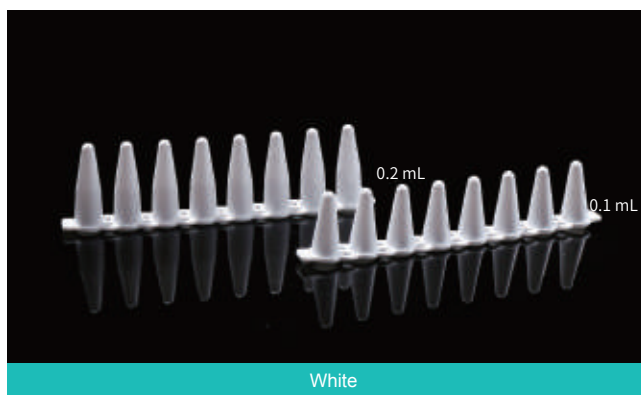

Volume (mL)	Color	Packing		Non-sterile Cat.No.	Sterile Cat.No.
		/Pack	/Case		
0.1	Transparent	125	10	403102	403122
	White	125	10	403112	403132
0.2	Transparent	125	10	403002	403022
	White	125	10	403012	403032

The transparent version is suitable for ordinary PCR reactions, and the white version is suitable for qPCR reactions.

The 0.1 mL tube is intended for overnight incubation experiments. It is specifically designed to be shorter than standard tubes to reduce contamination caused by condensation and the evaporation of the reaction solution. The design also increases the penetration intensity of fluorescent signals in qPCR.

The maximum capacity of the 0.1 mL tube is 150 μ L, and that of a 0.2 mL tube is 250 μ L.

● PCR 8-strip Tube Cap

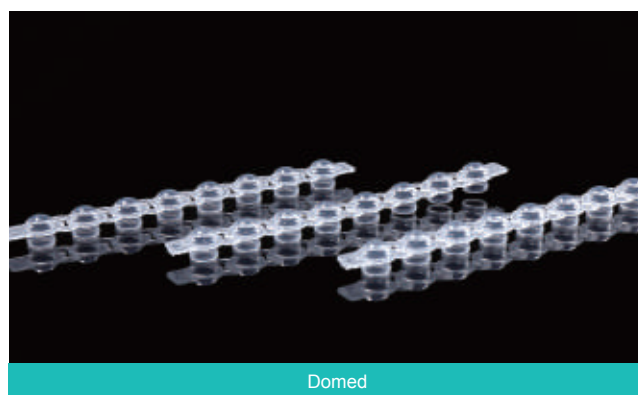
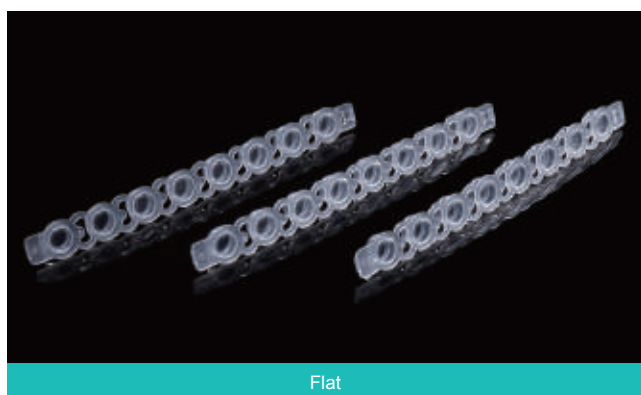

Cap Type	Color	Packing		Non-sterile Cat.No.	Sterile Cat.No.
		/Pack	/Case		
Flat	Transparent	125	10	406012	406022
Domed	Transparent	125	10	406112	406122

- Compatible with NEST 8-strip PCR Tubes or 96-well PCR plates.
- The cap design allows for easy opening and closing, securing better sealing performance.
- The flat caps are better for qPCR experiments.
- The domed cap can better prevent liquid evaporation.

PCR 96 Well Plate

When using a thermal cycler with the fluorescence detector above the samples, NEST white PCR plates effectively mutual interference between wells. The Nest white PCR plate also allows for high accuracy of detection when signal intensity is low, while Nest clear PCR plates are designed for PCR machines where the fluorescence detector is located below the sample plate.

● Features

- Made of high-quality polypropylene to ensure minimal loss of reaction solution.
- Flat surface, thick and solid, not easy to deform.
- The black ink-printing marks on the surface are easy to read and identify.
- Elevated edge of the hole can better prevent cross contamination.
- Compatible with NEST pressure sensitive film, self-adhesive film and hot sealing film.
- Autoclavable.
- The tube wall of transparent 96-well PCR Plate is thin, allowing for good light transmission.
- White PCR 96-well plate is better for qPCR experiments.
- The maximum capacity of the 0.1ml tube is 150 μ L, and that of a 0.2 mL tube is 250 μ L.
- Certified DNase/RNase and Pyrogen Free.

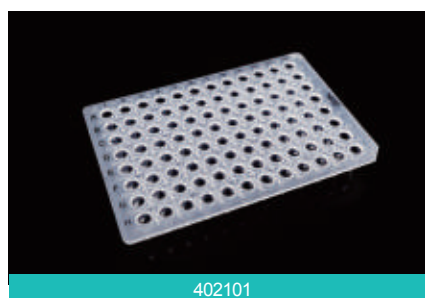

402101



402111



402812

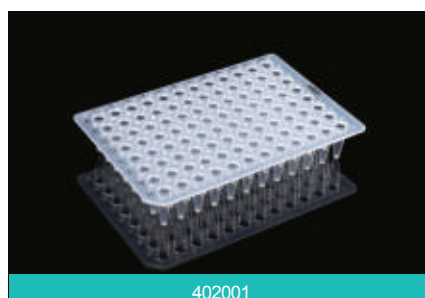

402001

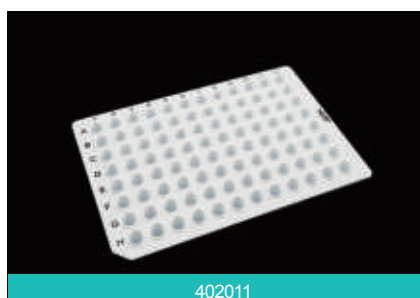

402011



402201

● PCR Plate, No Skirt

Volume (mL)	Cut Position	Color	Tube	Notes	Packing		Cat. No.
					/Pack	/Case	
96-well 0.1	H12	Transparent	Low profile	/	25	4	402101
	H12	White	Low profile	/	25	4	402111
	A12 / H12	White	Low profile	Compatible with Roche	10	5	402812
96-well 0.2	H1	Transparent	High profile	/	25	4	402001
	H1	White	High profile	/	25	4	402011
	H12	Transparent	Elevated Wells	/	25	4	402201

- The low-profile design minimizes the condensate contamination and evaporation of reaction solution.
- 0.1ml tube and 0.2ml tube

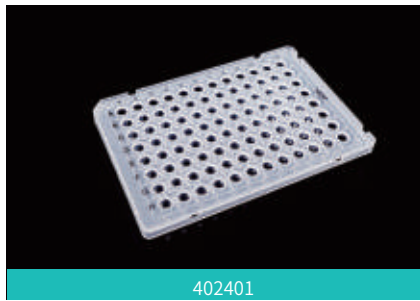

402401

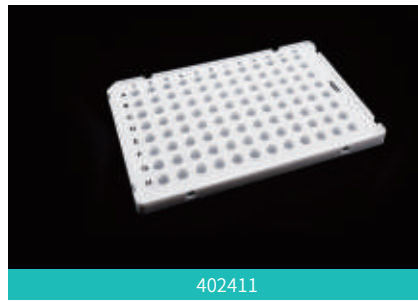

402411

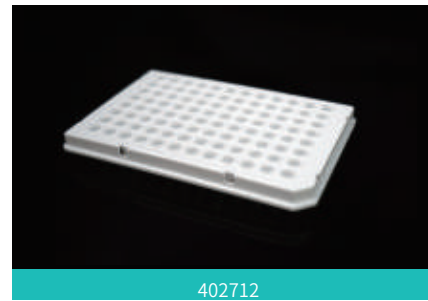

402712

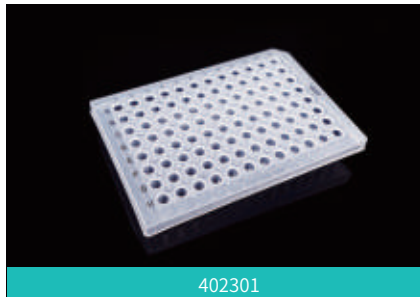

402301

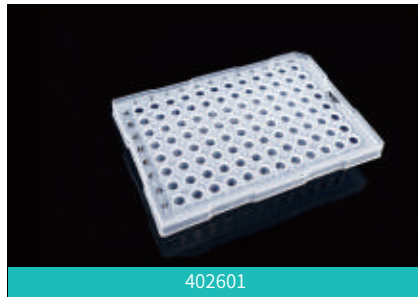

402601

● PCR Plate, Semi Skirt

Volume (mL)	Skirt Type	Notes	Cut Position	Color	Tube	Packaging		Cat.No.
						/Pack	/Case	
96-well 0.1	Semi Skirt	Compatible with ABI models	A1	Transparent	Low profile	25	4	402401
	Elevated Semi Skirt	/	A1	White	Low profile	25	4	402411
	Semi Skirt	Compatible with Roche	H12	White	Low profile	10	5	402712
96-well 0.2	Semi Skirt	/	A12	Transparent	High profile	25	4	402301
	Semi Skirt	Compatible with ABI models	A12	Transparent	High profile	25	4	402601

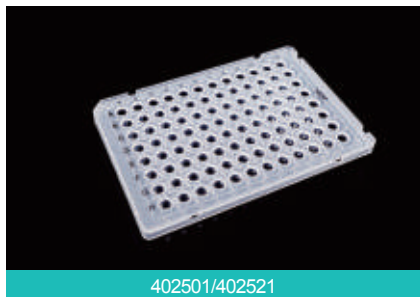

402501/402521



402511



409013/409033

● PCR Plate, Semi Skirt

Volume (mL)	Skirt Type	Notes	Cut Position	Color	Tube	Packaging		Cat.No.
						/Pack	/Case	
96-well 0.1 mL	Full Skirt	/	H1	Transparent	Low profile	25	4	402501
	Full Skirt	/	H1	White	Low profile	25	4	402511
	Full Skirt	Sterile	H1	Transparent	Low profile	25	4	402521
384-well 40 µL	Full Skirt	Compatible with Roche	A24+P24	White	Low profile	10	5	409013
	Full Skirt	Compatible with Roche, Sterile	A24+P24	White	Low profile	10	5	409033

● Compatibility

402712 Compatible with lightcycler 480、lightcycler 480 II、lightcycler 96
 402812 Compatible with lightcycler 96
 409013、409033 Compatible with lightcycler 480 II

● Precautions

- Select the appropriate plate according to the equipment
- During the experiment, the PCR film must be tightly attached to the plate to prevent evaporation

● PCR Rack

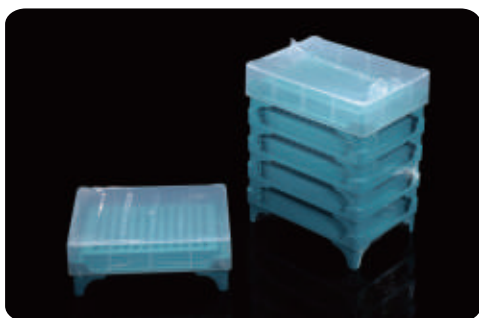

- Fits all NEST PCR products.
- Stackable.
- Autoclavable.

Specification	Cap Type	Color	Packaging		Cat.No.
			/Pack	/Case	
(1 Rack+1 Cap)/ Set, 8*12 Format	Flat	Blue rack+Transparent lid	1 rack +1 lid	25	407001
(5 Rack+1 Cap)/ Set, 8*12 Format	Flat	Blue rack+Transparent lid	5 rack +1 lid	5	407101

● PCR Sealing Film

NEST PCR sealing film is compatible with NEST 96-well ELISA Plates and 96-well PCR Plates in various applications such as the ELISA/PCR amplification reaction and PCR fluorescence quantification, etc. Both the regular PCR sealing film and high-transparency film are available.

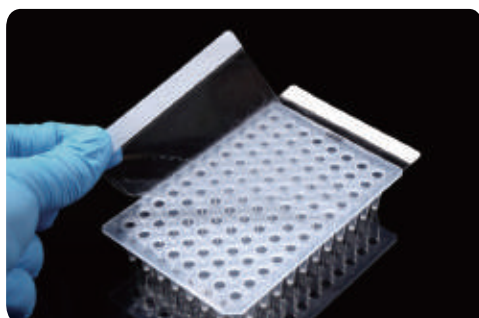

High Transparency PCR Sealing Film:

- NEST High Transparency PCR Sealing Film is made of a layer of transparent polypropylene film and a layer of transparent silicon-based pressure-sensitive adhesive.
- Applicable temperature is -70°C to 100°C.
- Pressure-sensitive film is non-adhesive to skin and gloves, which is convenient for experimental operation and does not affect optical analysis.
- Does not react with the experimental sample, the experimental results are more reliable.
- No autofluorescence.

Sealing Film:

- Material: non-permeable soft film; the adhesive is medical grade strong adhesive.
- Thickness: 100 µm.
- Economical and easy to use; compatible with a majority of PCR plates on the market.
- Good sealing performance.

Specification	Size (mm)	Color	Packing		Cat.No.
			/Pack	/Case	
Standard Sealing Film	146 × 81	Transparent	100	5	410001
Advanced Sealing Film	141 × 78	Transparent	100	5	410011
New PCR Sealing Film	141×83	Transparent	100	5	410021

Note: for life science laboratory research only, not for clinical drug treatment.
Recommended storage conditions: temperature range of 10-27 ° C; humidity range of 40%-60%.

● PCR Scraper

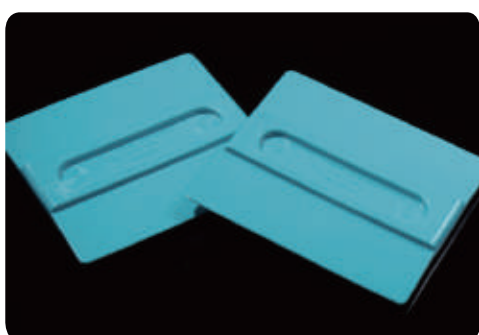

- NEST PCR Scraper is compatible with NEST High-transparency Sealing film and Standard Sealing Film, enabling the filming attached to the plates closer and ensuring better sealing performance.

Size (mm)	/Pack	Cat.No.
70*78	1	411001

Brand	Model	Number	PCR Tube										PCR Plates					
			401001	403002/404001	403102/403122	403112/403132	403012/403032	404001/403022	402001	402301	402501	402401	402101	402812	402601	402201		
Applied Biosystems®	2720		401001	403002/404001							404001/403022	402001	402301				402601	
	9600		401001	403002/404001							404001/403022	402001	402301				402601	
	9700		401001	403002/404001							404001/403022	402001	402301				402601	
	9800Fast				403102/403122										402401	402101		
	Veriti/Fast				403102/403122							402001	402301		402401	402101		402601
	7000		401001	403002/404001				403012/403032			404001/403022	402001	402301					402601
	7300		401001	403002/404001					403012/403032		404001/403022	402001	402301					402601
	7500Fast		401001	403002/404001	403102/403122				403012/403032		404001/403022	402001	402301		402401	402101		402601
	7700		401001	403002/404001							404001/403022	402001	402301					402601
	7900HT/Fast		401001	403002/404001	403102/403122						404001/403022	402001	402301		402401	402101		402601
	StepOne				403102/403122			403112/403132							402401	402101	402812	
	StepOnePlus				403102/403122			403112/403132							402401	402101	402812	
	ProflexPCRSytem		401001	403002/404001							404001/403022	402001	402301					402601
	QuantStudio 12K		401001	403002/404001							404001/403022	402001	402301					402601
	VIA7/Fast		401001	403002/404001	403102/403122				403012/403032		404001/403022	402001	402301		402401	402101		402601
	3100											402001	402301					402601
	3130											402001	402301					402601
3700											402001	402301					402601	
3730/3730x											402001	402301					402601	
Eppendorf®	Mastercycler®		401001	403002/404001						404001/403022	402001	402301		402501				
	Mastercycler® ep realplex		401001	403002/404001						404001/403022	402001	402301		402501				
	Mastercycler ep		401001	403002/404001						404001/403022	402001	402301		402501				
	Mastercycler nexus		401001	403002/404001						404001/403022	402001	402301		402501				
	Mastercycler nexus eco		401001	403002/404001						404001/403022	402001	402301		402501				
	Mastercycler nexus flat		401001							404001/403022								
	Mastercycler nexus flat eco		401001	403002/404001						404001/403022								



Eppendorf®	Mastercycler nexus gradient	401001	403002/404001					404001/403022	402001	402301	402501					
	Mastercycler nexus gradient eco	401001	403002/404001					404001/403022	402001	402301	402501					
	Mastercycler nexus GSX1	401001	403002/404001					404001/403022	402001	402301	402501					
	Mastercycler nexus GSX1e	401001	403002/404001					404001/403022	402001	402301	402501					
	Mastercycler nexus SX1	401001	403002/404001					404001/403022	402001	402301	402501					
	Mastercycler nexus SX1e	401001	403002/404001					404001/403022	402001	402301	402501					
	Mastercycler pro/S	401001	403002/404001					404001/403022	402001	402301	402501					
	3Prime	401001	403002/404001					404001/403022								
	3PrimeG	401001	403002/404001					404001/403022								
	3PrimeX	401001	403002/404001					404001/403022								
Techne®	Cyclogene™	401001	403002/404001					404001/403022	402001	402301	402501					
	Flexigene™	401001	403002/404001					404001/403022	402001	402301	402501					
	Genius	401001	403002/404001					404001/403022	402001	402301	402501					
	Genius Quad	401001	403002/404001					404001/403022	402001	402301	402501					
	Genius (TC412)	401001	403002/404001					404001/403022	402001	402301	402501			402101		
	Prime	401001	403002/404001					404001/403022	402001	402301	402501					
	Prime Elite	401001	403002/404001					404001/403022	402001	402301	402501					
	Prime Elite Satellite	401001	403002/404001					404001/403022	402001	402301	402501					
	PrimeG	401001	403002/404001					404001/403022	402001	402301	402501					
	Touchgene® Gradient (TC512)	401001	403002/404001	403102/403122				404001/403022	402001	402301	402501			402101		
	Touchgene® X	401001	403002/404001	403102/403122				404001/403022	402001	402301	402501			402101		
	PrimeQ	401001	403002/404001					404001/403022	402001	402301	402501					
	Quantica®	401001	403002/404001					404001/403022	402001	402301	402501					
	FlexCycler	401001	403002/404001	403102/403122				404001/403022	402001	402301	402501			402101		
	T1 Thermal Cycler	401001	403002/404001	403102/403122				404001/403022	402001	402301	402501			402101		
T Gradient	401001	403002/404001	403102/403122				404001/403022	402001	402301	402501			402101			
T personal	401001	403002/404001	403102/403122				404001/403022	402001	402301	402501			402101			
TP professional/Basic	401001	403002/404001	403102/403122				404001/403022	402001	402301	402501			402101			

Analytik Jena/
Biometra

Thermo Hybrid	Multiblock System	401001	403002/404001	403102/403122			404001/403022	402001	402301	402501	402101		
	T1 Thermal Cycler	401001	403002/404001	403102/403122			404001/403022	402001	402301	402501	402101		
	Omn-E	401001	403002/404001	403102/403122			404001/403022	402001	402301	402501	402101		
	Omnigene	401001	403002/404001	403102/403122			404001/403022	402001	402301	402501	402101		
	PCR Express	401001	403002/404001	403102/403122			404001/403022	402001	402301	402501	402101		
	PCR Sprint	401001	403002/404001				404001/403022						
	Px2	401001	403002/404001	403102/403122			404001/403022	402001	402301	402501	402101		
	PxE	401001	403002/404001	403102/403122			404001/403022	402001	402301	402501	402101		
	Touchdown	401001	403002/404001	403102/403122			404001/403022	402001	402301	402501	402101		
	Deltacycler I	401001	403002/404001	403102/403122			404001/403022	402001	402301	402501	402101		
Ericom	Single Block	401001	403002/404001	403102/403122			404001/403022	402001	402301	402501	402101		
	Twin Block	401001	403002/404001	403102/403122			404001/403022	402001	402301	402501	402101		
Stratagene	Mx3000®	401001	403002/404001					402001	402301				
	Mx3000P®	401001	403002/404001					402001	402301				
	Mx3005®	401001	403002/404001					402001	402301				
	Mx4000®	401001	403002/404001					402001	402301				
Agilent	SureCycler®8800	401001	403002/404001	403102/403122			404001/403022	402001	402301	402501	402401		
	ARIA MX G8830A				403112/403132						402812		
Qiagen®	Flexigene®	401001	403002/404001				404001/403022	402001	402301	402501			
	Rotor-Gene® Q	401001					404001/403022						
IMWG®	Primus 96	401001	403002/404001	403102/403122				402001	402301	402501	402101		
	peqSTAR 96	401001	403002/404001				404001/403022	402001	402301	402501			
SensoQuest	Thermocycle 96	401001	403002/404001					402001	402301	402501			
	Robocycler	401001	403002/404001				404001/403022	402001	402301	402501			
Takara®	TP240	401001	403002/404001					402001	402301	402501			
	天隆 TL988-IV				403112/403132								
	TP3000	401001	403002/404001	403102/403122			404001/403022	402001	402301	402501	402101		
Amersham®GE®	MegaBACE®500								402301	402501			
	MegaBACE1000								402301	402501			402201
Beckman Coulter®	CEQ™							402301					
Transgenomic	WAVE®System								402301	402501			

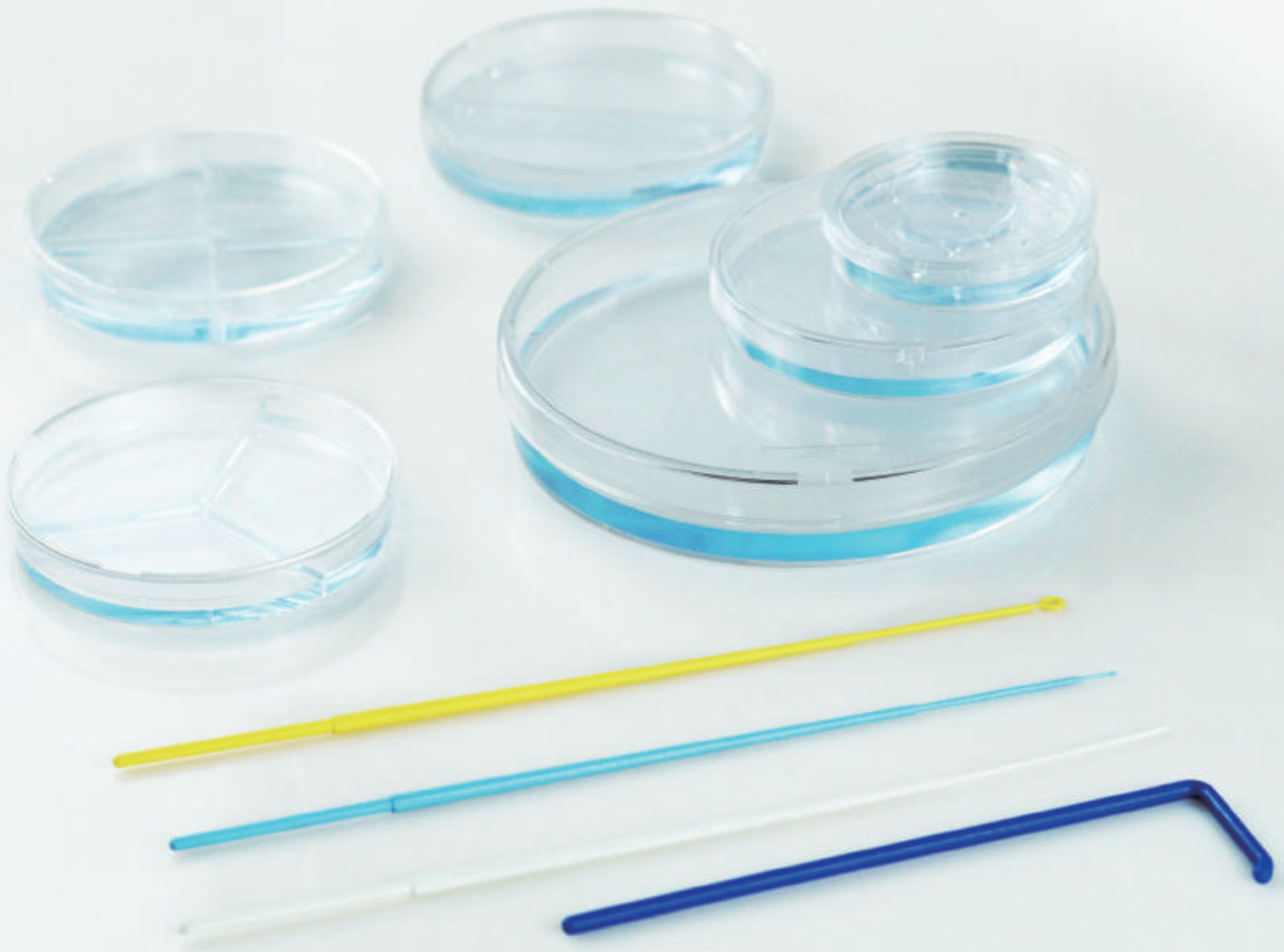

Bacteria

Petri Dishes

These non-treated polystyrene plates are transparent and DNase/RNase-Free. The bottom has a ridge allowing for easy handling and stacking. The plate has three vents for gas exchange.

- Made of high clarity, 100% virgin polystyrene.
- Numeric marks at 3/6/9/12 o'clock at the bottom, making it convenient for users to determine the position of bacteria.
- Flat, transparent surface.
- PA/PE composite film packaging.
- Stackable for easy storage and handling.
- Each package has an independent item number and batch number identification, which is convenient for quality tracking and traceability.
- Sterilized by E-beam, SAL=10⁻⁶.
- Non-Pyrogenic, DNase/Rnase free.



20 x 2

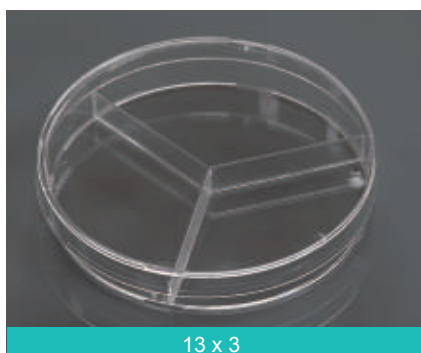

13 x 3

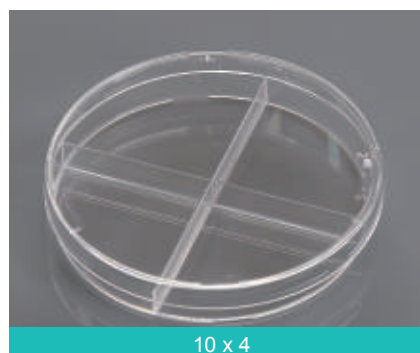

10 x 4

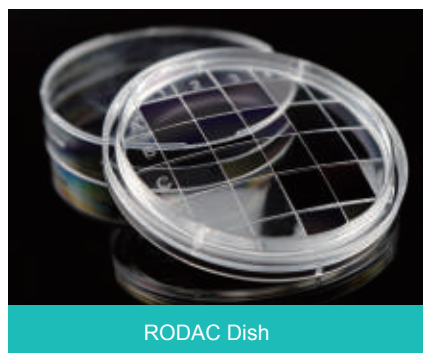

RODAC Dish



Petri Dish with Safe-lock Design

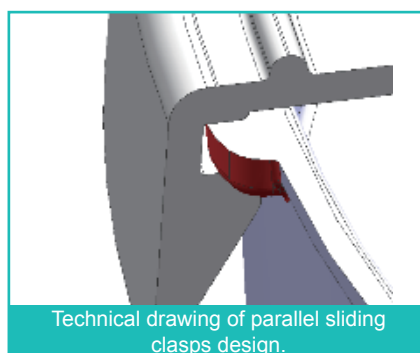

Technical drawing of parallel sliding clasps design.

• Petri Dishes

Spec (mm)	Height (mm)	Volume (mL)	TC	Sterile	Packing		Cat.No.
					/Pack	/Case	
35	12	5	NO	Sterile	20	25	706011
60	15	15	NO	Sterile	20	25	754001
90	15	40	NO	Sterile	20	25	752001
	15	40	NO	Sterile	20	25	752002 <small>Double-layer Packed</small>
	15	40	NO	Sterile	10	50	752004
	15	40	NO	Sterile	5	100	752003
	15	20 x 2 Compartments	NO	Sterile	20	25	752011
	15	13 x 3 Compartments	NO	Sterile	20	25	752021
	15	10 x 4 Compartments	NO	Sterile	20	25	752031
	15	40 Safe-lock Design	NO	Sterile	20	25	752101
100	20	40	NO	Sterile	20	15	752401
150	15	60	NO	Sterile	10	10	715011
	25	/	NO	Sterile	5	20	755001
65	15	13-15	NO	Sterile	20	25	722011

Innoculating Needles / Loops

L-Spreader

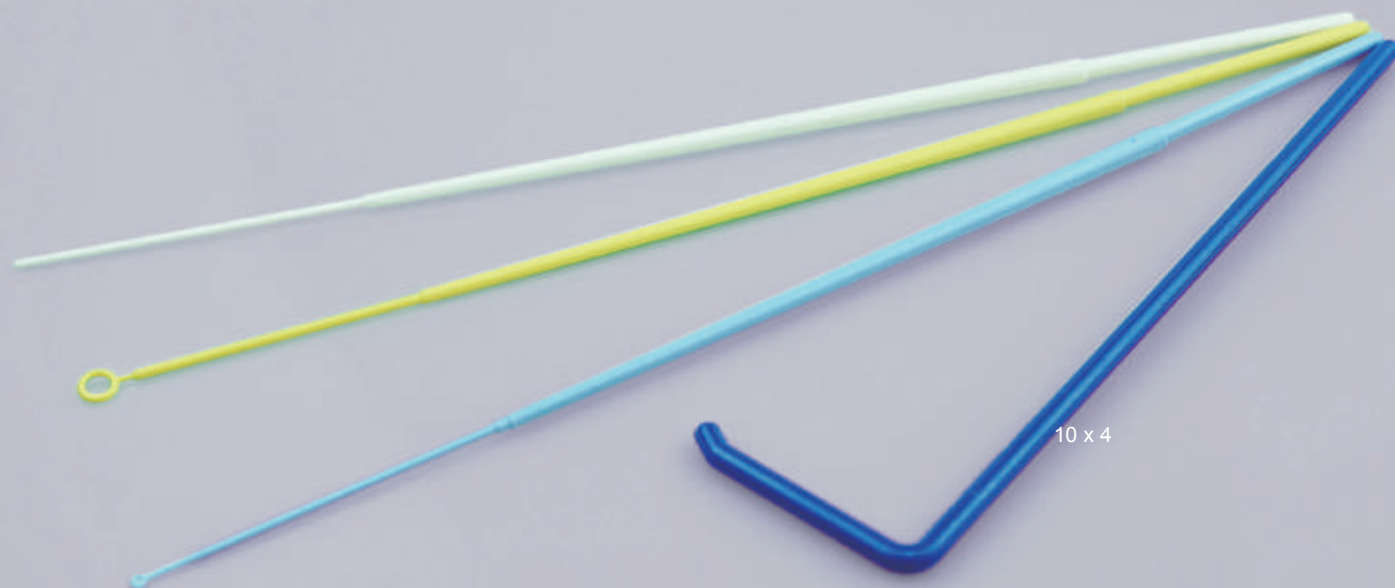

● Inoculating Needle / Loop

PP material, hydrophilic.

- Flexible handles for easier collection and inoculation.
- Applied in microbiology experiments.
- Different colors for identification.
- Easy-tear sterile individual packaging.
- Each package has an independent item number and batch number identification, which is convenient for quality tracking and traceability.
- Sterilized by Ethylene Oxide.
- Sterilized by E-beam, SAL=10⁻⁶.

● L-Spreader

- Sterile L-Spreader, made of using medical PS.
- Sterilized by E-beam, SAL=10⁻⁶.
- Smooth and flat surface that avoids problems such as contamination or uneven application of spread plate in bio-labs.
- Length of handle: 144mm, diagram of spreading: 33mm, suitable for 3.5cm, 6cm, 9cm, 10cm petri dishes and etc. Ideal for spreading cells or bacteria evenly in the culture dish.

Volume (μL)	Name	Color	Packing		Cat.No.
			/Pack	/Case	
/	Inoculating Needle	White	400	10	716001
1	Inoculating Loop	Blue	400	10	717101
10	Inoculating Loop	Yellow	400	10	718201
/	L-Spreader	Blue	200	10	711001



Medical Consumables

Disposable Swab

Registration Certification of Class II
Medical Devices Registration
No. : 20212221578.

Nasopharyngeal Swab Breakpoint

Oropharyngeal Swab Breakpoint Breakpoint

Oropharyngeal/Nares Specimen Collection Swab, Double Break Point Breakpoint Breakpoint

Oropharyngeal/Nares Specimen Collection Swab, Single Break Point Breakpoint

Capture Cap Swab Breakpoint

ADVANTAGE:

- Swab head is flocked nylon, and swab shaft is made of ABS (Acrylonitrile butadiene styrene).
- Non-toxic.
- Individually wrapped and sterile.
- CE, FDA, ISO certified.

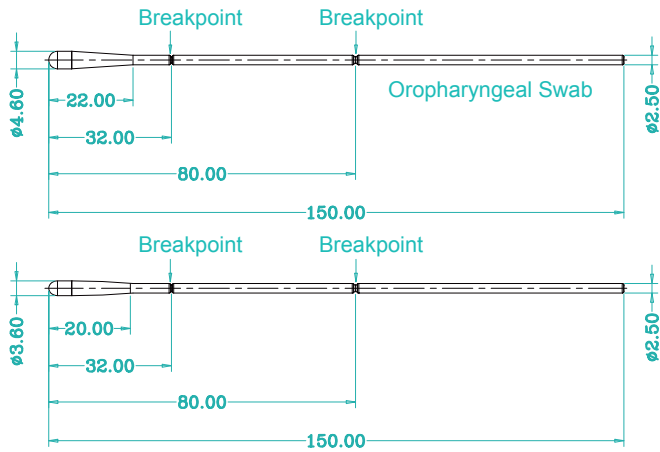

Oropharyngeal / Nares Specimen Collection Swab, Double Break Point

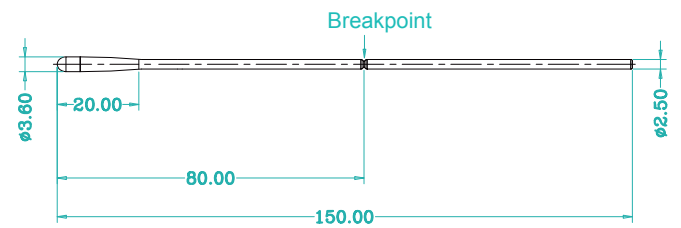
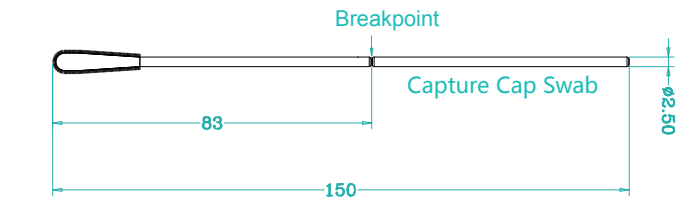
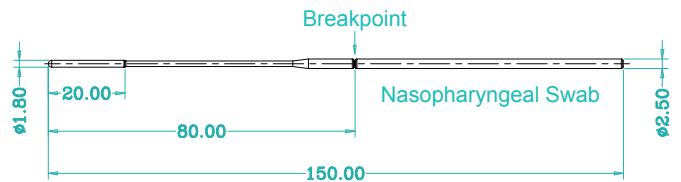

Oropharyngeal/Nares Specimen Collection Swab, Single Break Point

Cat.No.	Descriptions	/Pack	/Case
202003	Oropharyngeal Specimen Collection Swab, Individually Wrapped, Sterile	100	5000
202004	Nasopharyngeal Specimen Collection Swab, Individually Wrapped, Sterile	100	5000
202401	Oropharyngeal Specimen Collection Swab, Capture Cap Swabs, Individually Wrapped, Sterile	100	5000
202095 (NEW)	Oropharyngeal/Nares Specimen Collection Swab, Double Break Point, Individually Wrapped, Sterile	100	5000
202098 (NEW)	Oropharyngeal/Nares Specimen Collection Swab, Single Break Point, Individually Wrapped, Sterile	100	5000
202695	Disposable Sampler, 2 mL Vial, with Individually Wrapped and Sterile Oropharyngeal Swabs	10	50
202091	Disposable Sampler, 5 mL Vial, with Individually Wrapped and Sterile Nasopharyngeal Swabs	10	50



Viral Transport Medium



• Features

- Used for collection, storage and transportation of human nasopharyngeal virus samples.
- Unused VTM medium can be transported at room temperature.
- Sample transport temperature requirement & storage time: 2 to 4 C°, 48 h.

Cat.No.	Description	/Pack	/Case
202011	Disposable Sampler, 5 mL Vial with 2.5 mL VTM, with Individually Wrapped and Sterile Oropharyngeal Swab, 10 Vials/pk, 50 Vials + 50 Swabs/cs	10	50
202015	Disposable Sampler, 5 mL Vial with 2.5 mL VTM, with Individually Wrapped and Sterile Nasopharyngeal Swabs, 10 Vials/pk, 50 Vials + 50 Swabs/cs	10	50
202012	Disposable Sampler, 5 mL Vial with 2.5 mL VTM, with Individually Wrapped and Sterile Oropharyngeal Swabs, 1 Vial + 1 Oral Swab/pk, 100 pk/cs	1	100
202014	Disposable Sampler, 5 mL Vial with 2.5 mL VTM, with Individually Wrapped and Sterile Nasopharyngeal Swabs, 1 Vial + 1 NP Swab/pk, 100 pk/cs	1	100
202115	Disposable Sampler, 5 mL Vial with 2.5 mL VTM, 10 Vials/pk, 100 Vials/cs	10	100
202117	Disposable Sampler, 10 mL Vial with 3 mL VTM, 10 Vials/pk, 100 Vials/cs	10	100
202061	Disposable Sampler, 10 mL Vial with 3 mL VTM, with Individually Wrapped and Sterile Oropharyngeal Swab, 10 Vials/pk, 50 Vials + 50 Swabs/cs	10	50
202065	Disposable Sampler, 10 mL Vial with 3 mL VTM, with Individually Wrapped and Sterile Nasopharyngeal Swabs, 10 Vials/pk, 50 Vials + 50 Swabs/cs	10	50
202016	Disposable Sampler, 10 mL Vial with 3 mL VTM, with Individually Wrapped and Sterile Oropharyngeal Swabs, 1 Vial + 1 Oral Swab/pk, 100 pk/cs	1	100
202017	Disposable Sampler, 10 mL Vial with 3 mL VTM, with Individually Wrapped and Sterile Nasopharyngeal Swabs, 1 Vial + 1 NP Swab/pk, 100 pk/cs	1	100
202019	Disposable Sampler, 5 mL Vial with 2.5 mL VTM, with Individually Wrapped and Sterile Oropharyngeal & Nasopharyngeal Swabs, 1 Vial + 1 NP Swab/pk 1 Oral Swab/pk, 100 pk/cs	1	100
202018	Disposable Sampler, 10 mL Vial with 3 mL VTM, with Individually Wrapped and Sterile Oropharyngeal & Nasopharyngeal Swabs, 1 Vial + 1 NP Swab/pk 1 Oral Swab/pk, 100 pk/cs	1	100



Inactivation Transport Medium

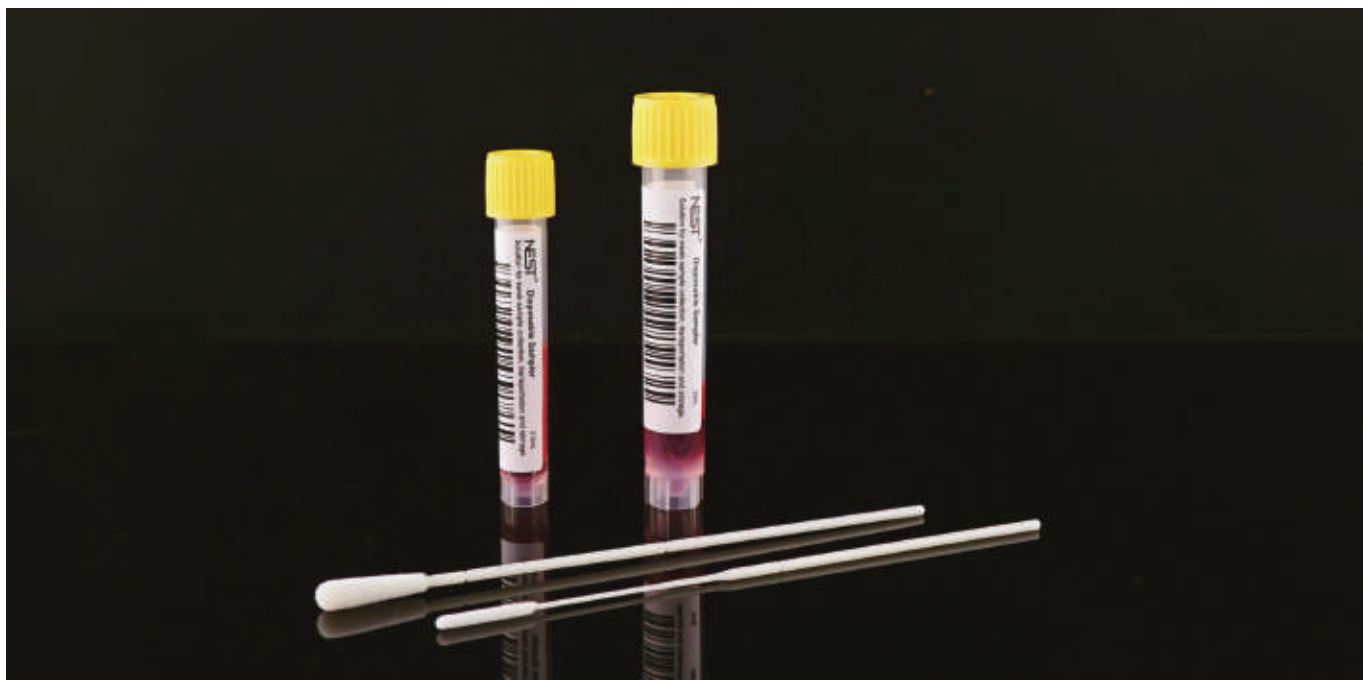

● Features

- ITM medium serves to both inactivate viruses and prevent nucleic acid degradation.
- Room temperature transport.
- Samples can be stored at room temperature for 20 days.
- Used for collection, storage and transportation of viruses, chlamydia, mycoplasma and urea plasma.

Cat.No.	Description	/Pack	/Case
202001	Disposable Sampler, 5 mL Vial with 2 mL ITM, with Individually Wrapped and Sterile Oropharyngeal Swab, 10 Vials/pk, 50 Vials + 50 Swabs/cs	10	50
202005	Disposable Sampler, 5 mL Vial with 2 mL ITM, with Individually Wrapped and Sterile Nasopharyngeal Swabs, 10 Vials/pk, 50 Vials + 50 Swabs/cs	10	50
202008	Disposable Sampler, 5 mL Vial with 2 mL ITM, with Individually Wrapped and Sterile Nasopharyngeal Swabs, 1 Vial + 1 NP Swab/pk, 100 pk/cs	1	100
202039	Disposable Sampler, 5 mL Vial with 2 mL ITM, with Individually Wrapped and Sterile Oropharyngeal & Nasopharyngeal Swabs, 1 Vial + 1 NP Swab/pk +1 Oral Swab/pk, 100 pk/cs	1	100
202006	Disposable Sampler, 10 mL Vial with 3 mL ITM, with Individually Wrapped and Sterile Oropharyngeal Swabs, 1 Vial + 1 Oral Swab/pk, 100 pk/cs	1	100
202007	Disposable Sampler, 10 mL Vial with 3 mL ITM, with Individually Wrapped and Sterile Nasopharyngeal Swabs, 1 Vial + 1 NP Swab/pk, 100 pk/cs	1	100
202038	Disposable Sampler, 10 mL Vial with 3 mL ITM, with Individually Wrapped and Sterile Oropharyngeal & Nasopharyngeal Swabs, 1 Vial + 1 NP Swab/pk 1 Oral Swab/pk, 100 pk/cs	1	100
202872	Disposable Sampler Pooling Kits, 10 mL Vial with 2 mL ITM, with Individually Wrapped and Sterile Nasopharyngeal Swabs, 1 vial + 5 swabs pool testing; 10 Vials/pk, 50 Vials/cs, 5 swabs/pk, 250 swabs/cs	1	50



Saline Transport Medium



● Features

- Non-toxic, safe and effective for home collection.
- Produced according to the FDA standard.
- Room temperature for transportation and storage.
- After collection of the sample transportation requirement: room temperature within 48h.
- Used for collection, storage and transportation of viruses, chlamydia, mycoplasma and urea plasma.
- Validation: 2 x LoD (low positives) and 10 x LoD (high positives) virus samples for 56 hours (40 °C for 12 hours, then 32 °C for 42 hours) in this product can be detected by RT-PCR.

Cat.No.	Description	/Pack	/Case
202041	Disposable Sampler, 5 mL Vial with 1.2 mL Saline Solution, with Individually Wrapped and Sterile Oropharyngeal Swabs, 10 Vials/pk, 50 Vials + 50 Swabs/cs	10	50
202045	Disposable Sampler, 5 mL Vial with 1.2 mL Saline Solution, with Individually Wrapped and Sterile Nasopharyngeal Swabs, 10 Vials/pk, 50 Vials + 50 Swabs/cs	10	50
202042	Disposable Sampler, 5 mL Vial with 1.2 mL Saline Solution, with Individually Wrapped and Sterile Oropharyngeal Swabs, 1 Vial + 1 Oral Swab/pk, 100 pk/cs	1	100
202044	Disposable Sampler, 5 mL Vial with 1.2 mL Saline Solution, with Individually Wrapped and Sterile Nasopharyngeal Swabs, 1 Vial + 1 Oral Swab/pk, 100 pk/cs	1	100
202049	Disposable Sampler, 5 mL Vial with 1.2 mL Saline Solution, with Individually Wrapped and Sterile Oropharyngeal & Nasopharyngeal Swabs, 1 Vial + 1 NP Swab/pk 1 Oral Swab/pk, 100 pk/cs	1	100
202141	Disposable Sampler, 5 mL Vial with 1.2 mL Saline Solution, 10 Vials/pk, 100 Vials/cs	10	100
202046	Disposable Sampler, 10 mL Vial with 3 mL Saline Solution, with Individually Wrapped and Sterile Oropharyngeal Swabs, 1 Vial + 1 Oral Swab/pk, 100 pk/cs	1	100



AMIES Transport Medium

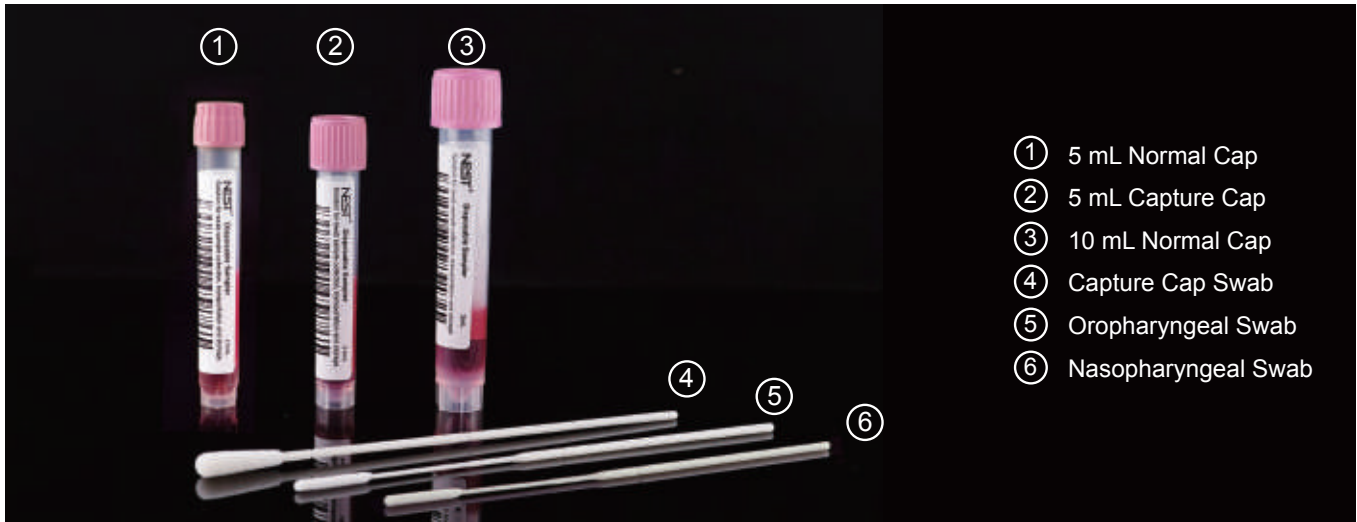

NEST disposable sampler (AMIES) is a collection and transport system which is used for aerobic, anaerobic and fastidious bacteria. In addition, NEST disposable sampler (AMIES) can be used for nucleic acid test of bacteria.

● Features

- Simplify specimen collection, transport and processing.
- Fewer samples need to be collected offering a more comfortable experience.
- Better preservation ability: the colony number of samples was reduced by no more than $1.5 \log_{10}$ after preservation for 48h.

Transport Temperature Requirement

Before using: AMIES solution can be stored at room temperature (5 to 25 degree centigrade) for twelve months.

After using: sample could maintain viability for up to 48 hours at room or refrigerator temperature (Neisseria gonorrhoeae survival at 24 hours per CLSI standard).



● Capture Cap & Swab

- Reducing the extra costs of stocking numerous swab types.
- Just screw the cap, the swab will be stuck onto the cap automatically without handling.

Cat.No.	Description	/Pack	/Case
202451	Disposable Sampler, 5 mL Vial with 1.2 mL ATM, with Individually Wrapped and Sterile Capture Cap Swabs, 10 Vials/pk, 50 Vials + 50 Swabs/cs	10	50
202452	Disposable Sampler, 5 mL Vial with 1.2 mL ATM, with Individually Wrapped and Sterile Capture Cap Swabs, 1 Vial + 1 Swab/pk, 100 pk/cs	1	100

Cat.No.	Description	/Pack	/Case
202051	Disposable Sampler, 5 mL Vial with 1.2 mL ATM, with Individually Wrapped and Sterile Oropharyngeal Swab, 10 Vials/pk, 50 Vials + 50 Swabs/cs	10	50
202055	Disposable Sampler, 5 mL Vial with 1.2 mL ATM, with Individually Wrapped and Sterile Nasopharyngeal Swab, 10 Vials/pk, 50 Vials + 50 Swabs/cs	10	50
202052	Disposable Sampler, 5 mL Vial with 1.2 mL ATM, with Individually Wrapped and Sterile Oropharyngeal Swabs, 1 Vial + 1 Oral Swab/pk, 100 pk/cs	1	100
202054	Disposable Sampler, 5 mL Vial with 1.2 mL ATM, with Individually Wrapped and Sterile Nasopharyngeal Swabs, 1 Vial + 1 NP Swab/pk, 100 pk/cs	1	100
202081	Disposable Sampler, 10 mL Vial with 3 mL ATM, with Individually Wrapped and Sterile Oropharyngeal Swab, 10 Vials/pk, 50 Vials + 50 Swabs/cs	10	50
202085	Disposable Sampler, 10 mL Vial with 3 mL ATM, with Individually Wrapped and Sterile Nasopharyngeal Swab, 10 Vials/pk, 50 Vials + 50 Swabs/cs	10	50
202056	Disposable Sampler, 10 mL Vial with 3 mL ATM, with Individually Wrapped and Sterile Oropharyngeal Swabs, 1 Vial + 1 Oral Swab/pk, 100 pk/cs	1	100
202057	Disposable Sampler, 10 mL Vial with 3 mL ATM, with Individually Wrapped and Sterile Nasopharyngeal Swabs, 1 Vial + 1 NP Swab/pk, 100 pk/cs	1	100



Universal Transport Medium

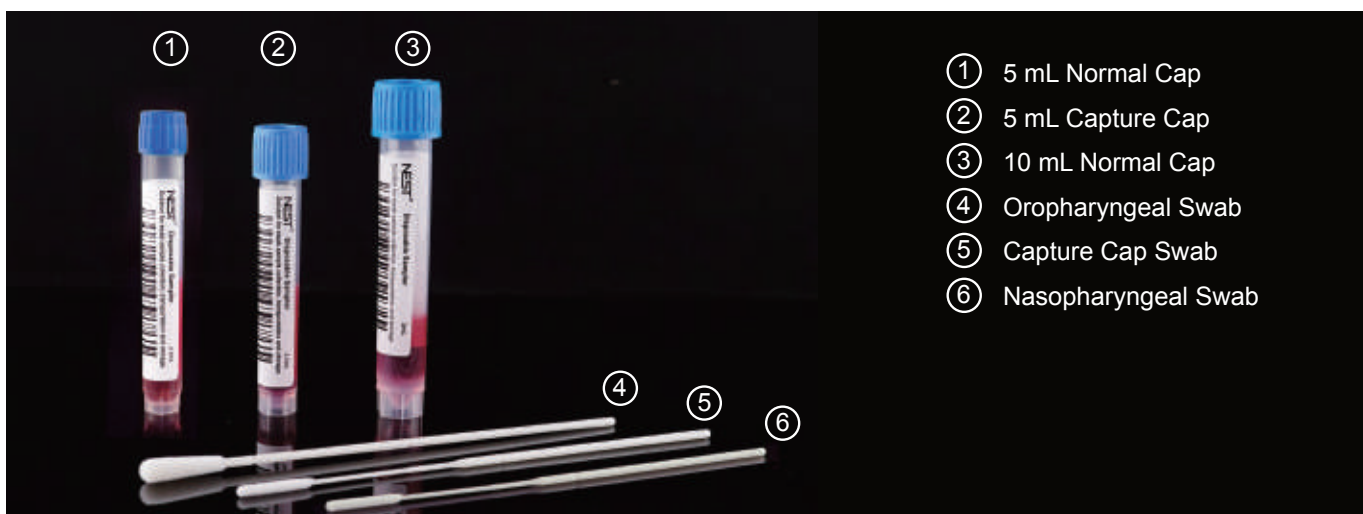

● Features

- Simplify specimen collection, transport and processing.
- Used for collection, storage and transportation of viruses, bacteria, chlamydia, mycoplasma and urea plasma. The specimen transported in the universal transport media can be used in the laboratory to perform pathogen isolation and detection.
- Disposable use.

Transport Temperature Requirement

This product can be transported at ambient temperature. The samples collected can be stored at the temperature of 2-8 °C if transported to the laboratory within 48 hours for the subsequent examination, inoculation and sample separation. Otherwise, please store the samples at -70 °C. Please store the samples at minus 70 degrees celsius, if they cannot be transported to the laboratory within 48 hours, please examine, inoculate, or separate the sample as soon as possible after being sent to the laboratory. Those that can be inoculated or separated within 48 hours can be stored at 4 degrees Celsius. Those that cannot be inoculated or separated within 48 hours should be stored at minus 70 degrees Celsius.



● Capture Cap & Swab

- Reducing the extra costs of stocking numerous swab types.
- Just screw the cap, the swab will be stuck onto the cap automatically without handling.

Cat.No.	Description	/Pack	/Case
202421	Disposable Sampler, 5 mL Vial with 1.2 mL UTM, with Individually Wrapped and Sterile Capture Cap Swabs, 10 Vials/pk, 50 Vials + 50 Swabs/cs	10	50
202422	Disposable Sampler, 5 mL Vial with 1.2 mL UTM, with Individually Wrapped and Sterile Capture Cap Swabs, 1 Vial + 1 Swab/pk, 100 pk/cs	1	100

Cat.No.	Description	/Pack	/Case
202021	Disposable Sampler, 5 mL Vial with 1.2 mL UTM, with Individually Wrapped and Sterile Oropharyngeal Swab, 10 Vials/pk, 50 Vials + 50 Swabs/cs	10	50
202025	Disposable Sampler, 5 mL Vial with 1.2 mL UTM, with Individually Wrapped and Sterile Nasopharyngeal Swab, 10 Vials/pk, 50 Vials + 50 Swabs/cs	10	50
202022	Disposable Sampler, 5 mL Vial with 1.2 mL UTM, with Individually Wrapped and Sterile Oropharyngeal Swabs, 1 Vial + 1 Oral Swab/pk, 100 pk/cs	1	100
202024	Disposable Sampler, 5 mL Vial with 1.2 mL UTM, with Individually Wrapped and Sterile Nasopharyngeal Swabs, 1 Vial + 1 NP Swab/pk, 100 pk/cs	1	100
202028	Disposable Sampler, 10 mL Vial with 3 mL UTM, with Individually Wrapped and Sterile Oropharyngeal Swab, 10 Vials/pk, 50 Vials + 50 Swabs/cs	10	50
202029	Disposable Sampler, 10 mL Vial with 3 mL UTM, with Individually Wrapped and Sterile Nasopharyngeal Swab, 10 Vials/pk, 50 Vials + 50 Swabs/cs	10	50
202026	Disposable Sampler, 10 mL Vial with 3 mL UTM, with Individually Wrapped and Sterile Oropharyngeal Swabs, 1 Vial + 1 Oral Swab/pk, 100 pk/cs	1	100
202027	Disposable Sampler, 10 mL Vial with 3 mL UTM, with Individually Wrapped and Sterile Nasopharyngeal Swabs, 1 Vial + 1 NP Swab/pk, 100 pk/cs	1	100



Disposable Intranasal Atomization Device

● Product Presentation

- The device provides a painless and rapid absorption medication delivery option for non-invasive intranasal medication delivery. It improves safety for both caregivers and patients by avoiding needle-sticking injuries.
- It is an atomizing device for drug administration intended to convert liquid preparations into atomized particles and spray on the surface of human body tissues (or organs) for full contact to maximize the administration effect. Meanwhile, the reasonable and effective self-destructive structure ensures that the product can only be used once to provide users with safe and hygienic products.

● Main Components

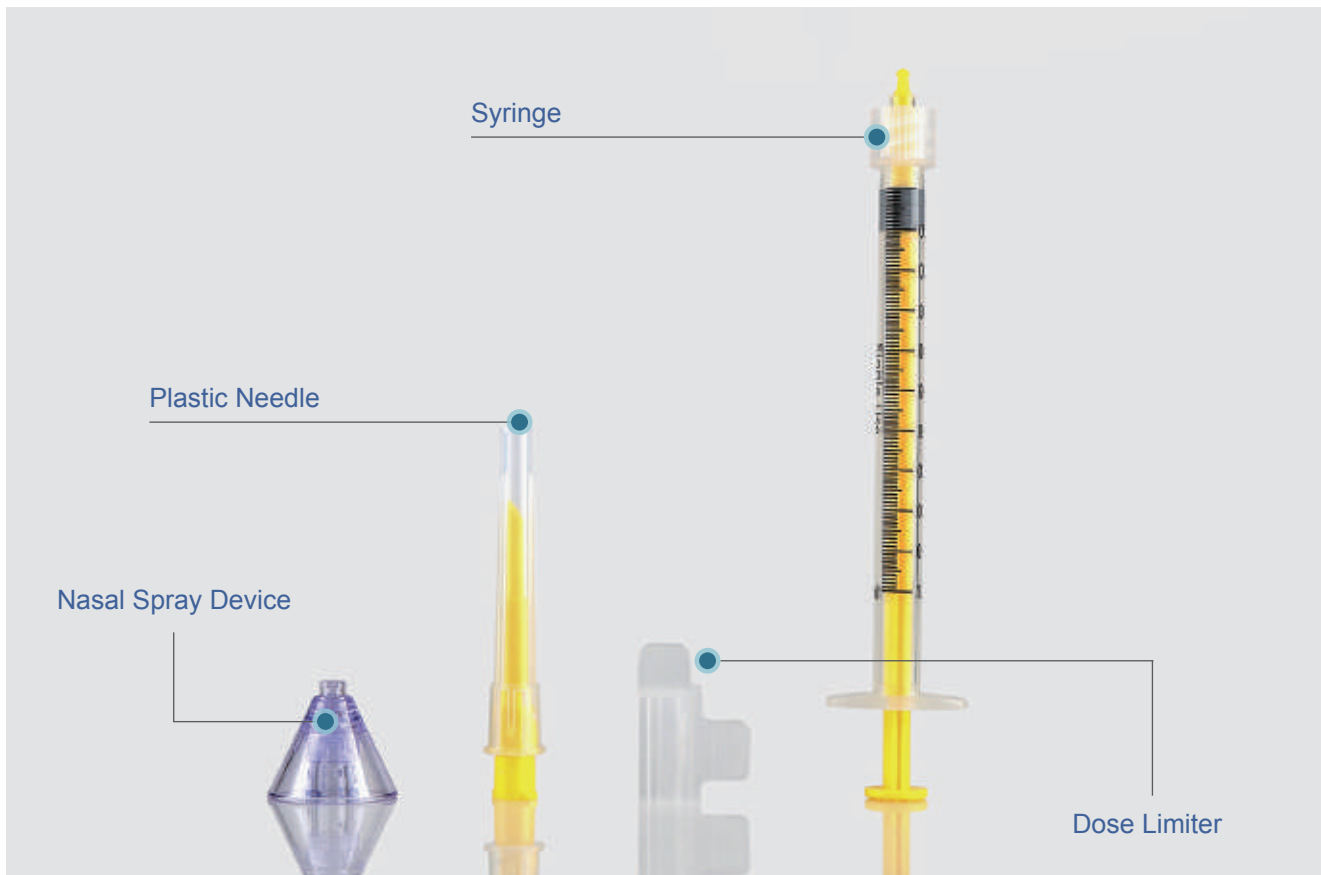

● Product Parameters

Product Description	Color	/Pack	/Case	Cat.No.
Disposable Intranasal Atomization Device, White, with Plastic Needle, Syringe, Nasal Spray Device, Dose Limiter, Individually Packed	White	1	1000	201003
Disposable Intranasal Atomization Device, Yellow, with Plastic Needle, Syringe, Nasal Spray Device, Dose Limiter, Individually Packed	Yellow	1	1000	201113



Initiative

The first Chinese company to invent this device.

Patent No.
CN201820609059.4
CN202020350634.0
CN202010194009.6

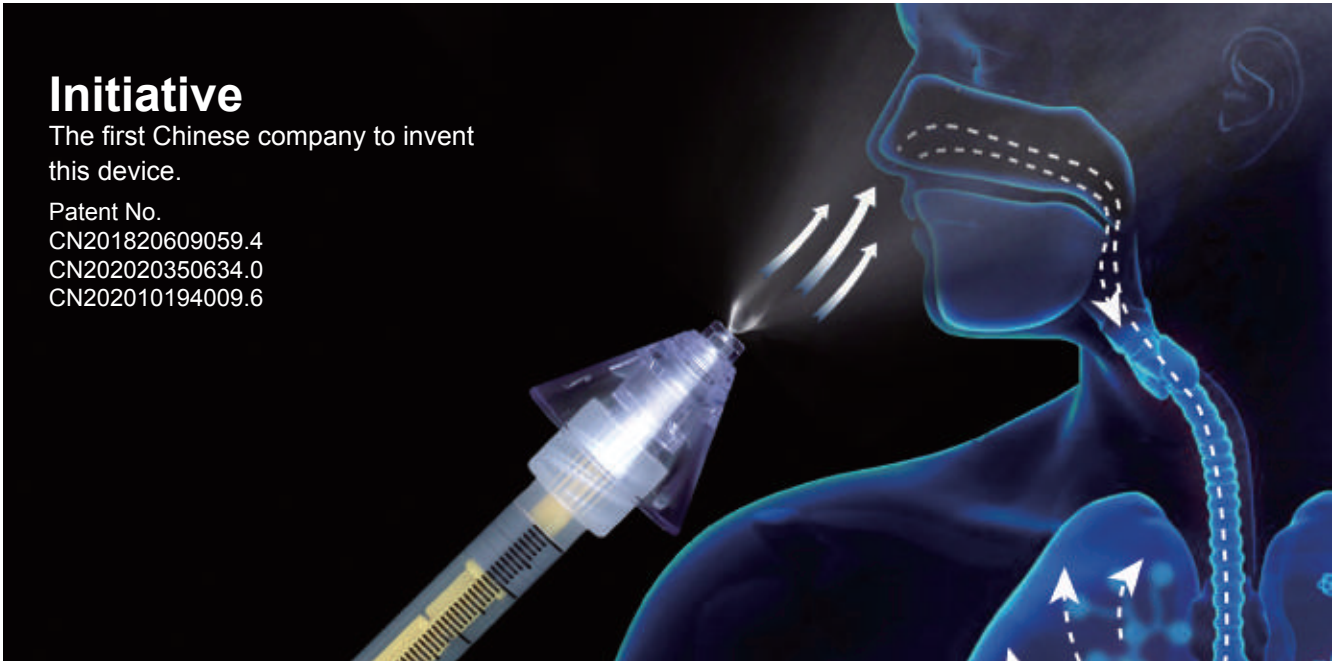

**Rapid
Absorption**



**Non-invasive
& Painless**



**Self-Destruct
Device**



**Special Dose
Limiter**

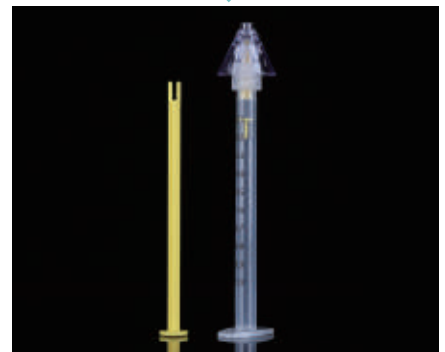

**Inoculate
Precisely**

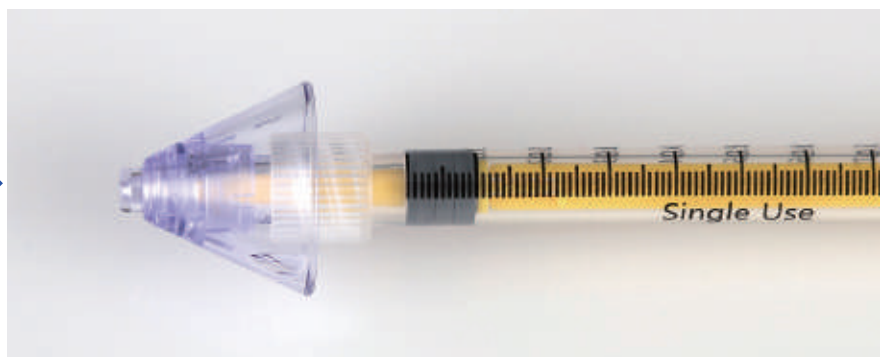

Dry Saliva Collection Kits

● Features

- USP VI Polypropylene Tubes.
- Collection process is painless and safe.
- The humanized design of funnel conforms to the mouth shape of human, making the collection process simple and easy.
- Good sealing performance effectively prevents leakage and specimens contamination safely and reliably, making it easy to preserve and transport specimen.
- The bottom of the collecting vial is conical, making it easy to process concentrated sample.
- Bar codes makes digital management easier, and labels with writing areas are convenient for users to record information.
- RNase/DNase free, non-pyrogenic.

Cat.No.	Volume (mL)	Upper Cup	Sterile	Contents	/Pack	/Case
 203101	5 mL	Screw Funnel	Sterile	Screw Funnel 5 mL Vial Specimen Bag Cap	1	100
 203102	10 mL	Screw Funnel	Sterile	Screw Funnel 10 mL Vial Specimen Bag Cap	1	100
 203111	5 mL	Wedged Funnel	Sterile	Wedged Funnel 5 mL Vial Specimen Bag Cap	1	100
 203112	10 mL	Wedged Funnel	Sterile	Wedged Funnel 10 mL Vial Specimen Bag Cap	1	100
 203901	Wedged in Funnel		Sterile	Compatible with different tube diameters ranging from 9.5-20.0 mm	1	100



Dry Saliva Collection Kits



● Features

- Applied at room temperature.
- The 5 mL preservation solution vial is filled with 2 mL ITM solution.
- Samples can be stored and transported at room temperature.
- DNA samples can be stored stably for 12 months.
- RNA samples can be stored steadily for 1 month.
- With good antibacterial performance and strong storage stability, the preservation solution can guarantee the integrity of viral nucleic acids in the sample if it is used to store inactivated viral samples.

● Introduction

- The cap of the Preservation Solution Tube should always be securely fastened to prevent accidental ingestion.
- The delicate design allows the preservation solution automatically to flow into the storage vial, eliminating direct contact with the preservation solution at all stages.
- The ITM Inactivation Preservation Solution, which deactivates viruses while preventing nucleic acid degradation, effectively prevents accidental contact or infection during transportation and testing.
- The device can be conveniently stored or transported at room temperature.
- It ensures a comfortable collection process without causing pain or damage to the human body. It is particularly suitable for children and patients who cannot provide a blood sample.

● Introduction

- The product is used to collect high-quality DNA/RNA samples in the saliva.
- The collection process is painless and won't cause any injury or discomfort to the human body.
- The collected samples can be used for various biological experiments such as enzymatic hydrolysis, PCR and next-generation sequencing and are widely used in the collection and preservation of specimens in hospitals, scientific research institutions and households.

● Instructions

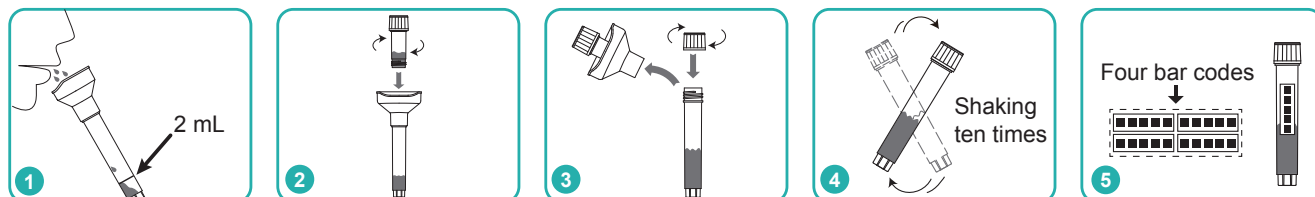

Take a barcode out and stick it on the saliva collection tube. Then place the tube with the attached barcode and two additional barcodes into the sample bag for later storage, transportation or testing. The user should retain the remaining barcode for future reference or feedback.

Description	/Pack	/Case	Cat.No.
Disposable Sampler, Saliva Collection Kit with ITM, each kit Includes a 10 mL Vial with a funnel, a separate 5 mL Vial filled with 2.0 mL ITM, Sterile Pack, 100 kits/case	1	100	203011

Saliva/gargle Collection Kit

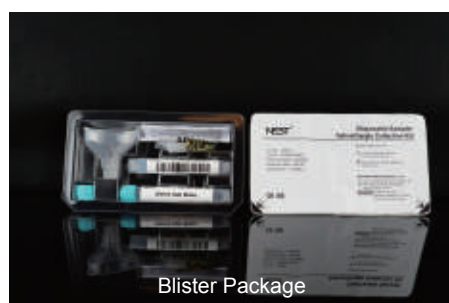

Introduction

The disposable sampler saliva/gargle collection kit is intended for the collection and transport of clinical samples from the collection site to the testing laboratory. As it will not cause any discomfort to the collection object, it is easy to be accepted. Both saliva and gargling method will be presented in this IFU either method is at your choice. This product is easy to carry and operate.

Features

- Applied at normal ambient temperature.
- The kit process is simple, convenient and easy to operate.
- Flexible to use, can be easily collected in the laboratory, clinic, or even at home.
- It is suitable for a wide range of target group, especially for children and patients who do not meet the blood sample collection conditions.
- The non-invasive collection of samples will not cause any discomfort to the collection objects, reducing the chance of infection and improving safety.

Description	Packing	/Pack	/Case	Cat.No.
Disposable Sampler, Saliva/Gargle Collection Kit, each kit Includes a funnel, an empty 5mL vial, a 5 mL Vial Filled with 4.0 mL saline, Sterile	Paper Box Package	1	100	203051
	PE Bag Package	1	100	203061
	Blister Package	1	100	203071





Pharmaceutical Packaging

AccureVial™ COP Bottle



● Product introduction

The main raw material for NEST AccureVial™ COP Bottle is cyclic olefin copolymer (COP). As a substitute for borosilicate glass, COP has the characteristics of high transparency, high rigidity, high heat resistance, low refractive index, low protein adsorption, and drug compatibility test producing no flake. The applicable temperature range of the bottle body is 121 °C ~ -196 °C.

NEST AccureVial™ COP Bottle is featured with good steam tightness and resistance against acid, alkali and abrasion. This product is sterilized by electron beam and can be directly used for prefilling of injection solution, freeze-dried powder and other kinds of drugs and easy to be stored and transported.

● Product features



Certified quality

COP raw materials meet USP Class VI standards and products are 100% fully inspected.

Production and packaging are carried out in a GMP standard workshop which conforms to ISO 9001 and ISO 15378 standards.



Precision detection

Relying on imported injection molding equipment and sophisticated testing instruments, the precise size and optimized appearance are obtained to ensure the high quality of the products.



Easy to use

Sterilized by E-beam, SAL=10⁻⁶, Non-Pyrogenic, Can be directly applied to prefilling



Tailor-made for customers

Various specifications are available, customers can choose according to the required specifications. Special packaging customization is also available.

● Applications

NEST AccureVial™ COP Bottle is mainly used in the packaging of highly stable complex molecules and sensitive drugs, such as anti-cancer, anti-tumor, cardiovascular and cerebrovascular biological reagents, which usually have high added value. For drugs or high protein content drugs with PH value greater than 9, NEST Penicillin COP Bottle is suitable for packaging and transportation.

Description	/Pack	/Case	Cat.No.
5 mL AccureVial™ COP Bottle	1	10	207001

Notes: This specification is presented as a model. It can be tailored to meet your specific requirements.

Pre-filling Disposable Glass Intranasal Atomization Device



● Introduction

NEST Pre-filled Disposable Glass Intranasal Atomization Device, a kind of pharmaceutical packaging material with good stability and compatibility, is intended for long-term storage of medicine. During administration, it can convert the liquid preparation into uniformly atomized particles and spray them on the surface of the patients' mucous membrane (nasal and oral mucosa) to maximize medication effect. The device is pre-filled with liquid preparation and sealed for storage and transportation. Therefore, both the process of transferring liquid preparation into syringe and the manual work involved are saved. Besides, medicine loss or waste for residue is solved. Meanwhile, safety and sanitation problems are also decreased since the contamination risk for liquid and device during transfer is reduced.

● Features

• Stable Material

Made of high quality medium borosilicate glass, which is extensively applied in pharmaceutical packaging including biological agents and vaccines, the product possesses strong chemical durability and shock resistance.

• Hermetically Sealed

The spray is equipped with a protection cap, which is embedded with sealing ring to ensure its leak-proofness and virus-resistance during transfer and transportation.

• Perfect Atomization Effect

Atomization cavity with precision turbine design ensures uniformly atomized particles evenly distributed on human mucous membrane for ideal liquid atomization effect.

• Precise Dose

The precise Dose Limiter ensures the uniformity of each dose .

• Single Use Design

The device is set with self-destruct design. After administration, the stopper will stick in the syringe and can't be taken out for a second use.

● Application

Intranasal Medication through mucous membrane absorption is an efficient treatment method. Nasal mucosa is moist and smooth with rich blood vessels. Nasal drug droplets and intranasal atomization medication can not only locally diminish inflammation, resist the bacteria and viruses, unblock a stuffy nose and stop bleeding, etc., but also can act throughout the body. For instance, Antipyretic analgesic An- alginum can abate fever if nasally delivered in droplets.

Compared with intravenous drug delivery and other modes of administration, Intranasal medication has more advantages: For example, the activity of nasal mucosal hydrolase is lower than that of the gastrointestinal tract, which reduces the degradation of polymer compounds such as polypeptides, hormones, vaccines and other drugs and ensures drug delivery effect; Secondly, it can avoid the liver first-off effect and the damage to the liver caused by oral drugs, etc.; Thirdly, its high bioavailability can achieve brain targeted drug delivery; Finally, it is easy to operate and convenient for infants and children with few adverse reactions and good compliance.

In recent years, due to the special advantages of intranasal administration, nasal spray vaccines have also become a new direction for research and application. Studies have shown that nasal mucosal immunity can induce not only local mucosal immune responses, but also the systemic immune responses, whose effects are similar to subcutaneous immunization, and even more effective and intense than oral immunization. Nasal spray vaccines further enlarge the application of intranasal administration.

Pre-filling COP Syringe with Luer Lock

● Introduction

NEST Pre-filled COP Syringe with Luer Lock is a syringe made from Cycloolefin Copolymer (COP), mainly intended for the packaging and storage of high-end drugs and vaccines which can be used directly for injection, as well as other surgical irrigation in ophthalmology, otology, orthopedics, etc..

Compared with traditional syringes, NEST Pre-potting COP Syringe with Luer Lock have clear edges in terms of process and application.

● Advantages

• Secondary Contamination Avoided

Pre-injection drug dispensing process saved and drug contamination risk reduced.

• Precise Drug Ingredients Proportion

The proportion of drug ingredients is set at the factory to avoid changes in the proportion of on-site dispensing.

• COP Merits

- Cycloolefin Copolymer (COP) are amorphous transparent polymers with a cyclic olefin structure that can be better dimensionally controlled than glass.
- High transparency, rigidity, heat/ fracture resistance; good water vapor tightness; and low birefringence, water absorption, etc.;
- Stable physical and chemical properties, low protein adsorption, good compatibility with drugs without de-tableting. Mature application cases indicate that COP material is used as the pharmaceutical packaging material by many drugs series globally ;
- Suitable for ethylene oxide sterilization and steam sterilization.

• Luer Lock

The Luer Lock adopts the national standard design size and is compatible with other products which can connect with Luer Lock such as injection heads, spray heads, and infusion sets etc.. The connection is firm with top sealing strength.

● Product Design

It adopts the design of Luer Cone head and Luer Lock in one, inside which the Luer Hole can connect to the needleless connection device.

It consists of ① the syringe ② butyl Protection Cap ③ piston ④ Push Assistor ⑤ Push Rod

● Product application

Pre-filled COP Syringe with Luer Lock is mainly intended for the packaging and storage of vaccines, biological agents and high value-added medicine. Currently, the proportion of therapeutic injectable drugs in the market is increasing year by year, and the application of pre-potting has been broadened to many of the following fields:

- Vaccines
- Anti-infectives
- Haematological agents
- Hormone therapies
- Cancer therapies
- Anti-coagulants
- Anti-inflammatory agents
- Multiple sclerosis therapies
- Obstetric agents
- Pain relievers

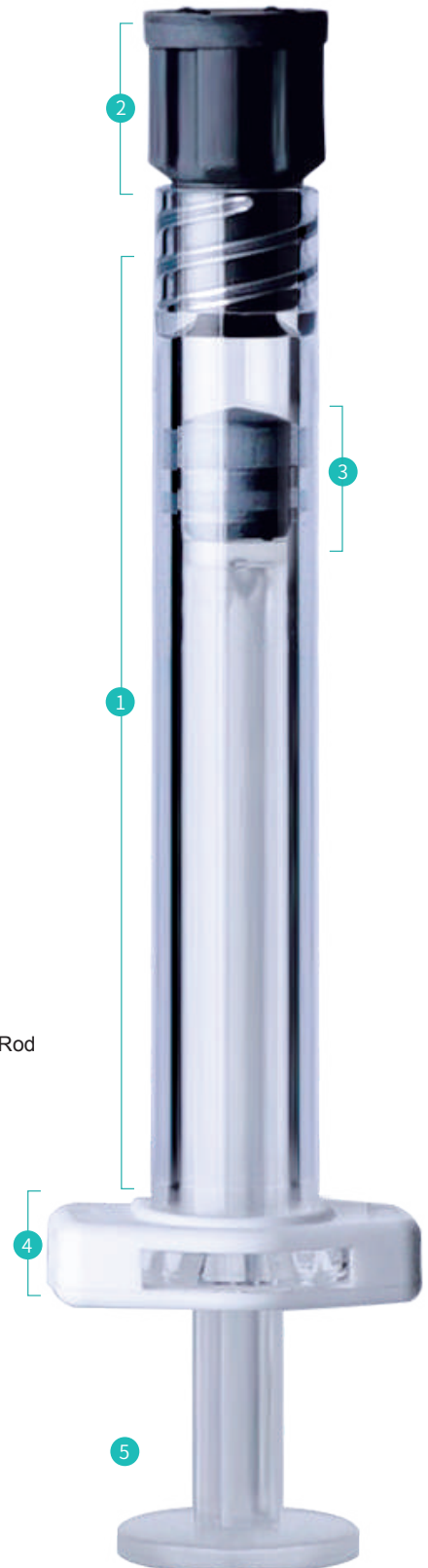

Pen Injector





Disposable Pen Injector



Reusable Pen Injector

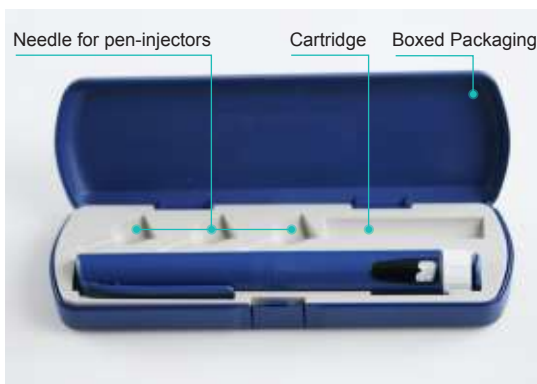

Pen Injector is a type of reusable liquid medicine injection device that contain liquid medicine solution with a syringe. The Liquid medicine medication is placed in the pen in a cartridge, eliminating the need to extract liquid medicine each time. To administer the medication, simply remove the pen cap, adjust the dial to the desired dose, and then perform the liquid medicine injection.

Currently, NEST Pen Injector are available in two categories: Reusable Pen Injector and Disposable Pen Injector. NEST Pen Injectors have been developed specifically for use with standardized 3mL injection vials and needles as outlined in ISO 11068-3 and 11068-2. This user-friendly device is not only reusable but also offers the convenience of dose adjustments according to individual needs, granting patients flexibility in self-administration. To pre-set the desired dosage, simply adjust the dosage adjustment knob to the required dose. The plunger handle of the injector operates by engaging gears, which in turn drives a screw thread to move radially. This radial movement simultaneously pushes the cartridge plunger within the medication chamber, causing the medication to be injected into patient's body through a disposable needle in a precise and accurate way.

Application

NEST Pen Injectors have been developed specifically for use with standardized 3mL injection vials and needles as outlined in ISO 11608-3 and 11608-2. This product can be used for a wide variety of self-injectable medications such as insulin, weight-loss drugs (e.g. semaglutide), interferon, hormones (e.g. testosterone cypionate) and others.

Features

Enlarged view window

The clear scale provides a convenient observation of the dosage.

Portable and convenient

The small and delicate package makes it highly portable.

Flexible adjustment

The dosage adjustment knob can be adjusted in both directions, allowing for easy correction in case of excessive dosage.

Precision injection

The injection-moulded screw thread ensures high precision and low margin of error, resulting in a stable injection process. The injection increment is 1IU, and the reusable pen injector range 1IU-60IU, the disposable pen injector range 1IU-60IU/1IU-80IU

Smooth injection

The transmission mechanism is completely made of special materials with high lubrication, ensuring a smooth injection process with a required pressure of less than 30N.

User-friendly

It is easy for beginners to use, eliminating the need for professional guidance.



● Disposable Pen Injector

After use, throw away the pen with the refill and replace it with a new one.

Convenient

Liquid medicine solution can be pre-filled into, eliminating the need for multiple refilling.

Hygienic and safe

It provides a hygienic and safe solution as it appears as a new pen for each use, eliminating the need for cleaning and disinfection and reducing the risk of cross-contamination.

Accurate dosage

Dosage can be pre-set according to individual needs, granting patients the flexibility for their liquid medicine administration.

Supports customization

Supports customization in multiple colors.

Cat. No.	206301	206321
Injection range	0~80 units (0.8mL)	0~60 units (0.6mL)
Packaging	1 pc/pk, 200 pcs/cs	
Material	Pen body: ABS	
Name	Disposable Pen Injector (NEST)	
Single Minimum Dose	1 unit (0.01 mL)	
Application	Suitable for a variety of disposable injection needles: such as BD, Jierui injection needles, etc. The needles must comply with ISO 11608-2. Applicable to the injection of standard 3 mL cartridge solution: 3 mL cartridge refills must comply with ISO 11608-3.	

● Technical Drawing



● Reusable Pen Injector

When the refill is used up, replace the refill for reuse.

Cost-effective

Compared to disposable pen injectors, it is more affordable and economical.

Environmental-friendly

By generating less plastic waste than disposable products, the reusable pen injector promotes a greener approach.

Long service life

The device maintains precise and accurate medication even after prolonged use.

High compatibility

It is compatible with a wide range of needles and 3ml cartridges available in the market, allowing for convenient refilling.

Bagged Packaging	206211 (1 pc/pk, 200 pcs/cs)	206321 (1 pc/pk, 200 pcs/cs)
Boxed Packaging	206212 (1 pc/box, 100 boxes/case)	206232 (1 pc/box, 100 boxes/case)
Description	Plastic pen body with large window	Plastic pen body with small Window
Model No.	NIVR-01	NIVR-02
Material	Pen body: ABS	
Injection range	0 ~ 60 units (0.6 mL)	
Name	Reusable Pen Injector (NEST)	
Single Minimum Dose	1 unit (0.01 mL)	
Application	Compatible with disposable injection needles in line with ISO 11608-2, including BD, Jierui injection needles, etc; Compatible with standard 3 mL cartridge that complies with ISO 11608-3.	



Plastic pen body with large window



Plastic pen body with small Window



Lab Safety

Nitrile Examination Glove



Nitrile Powder Free Examination Gloves

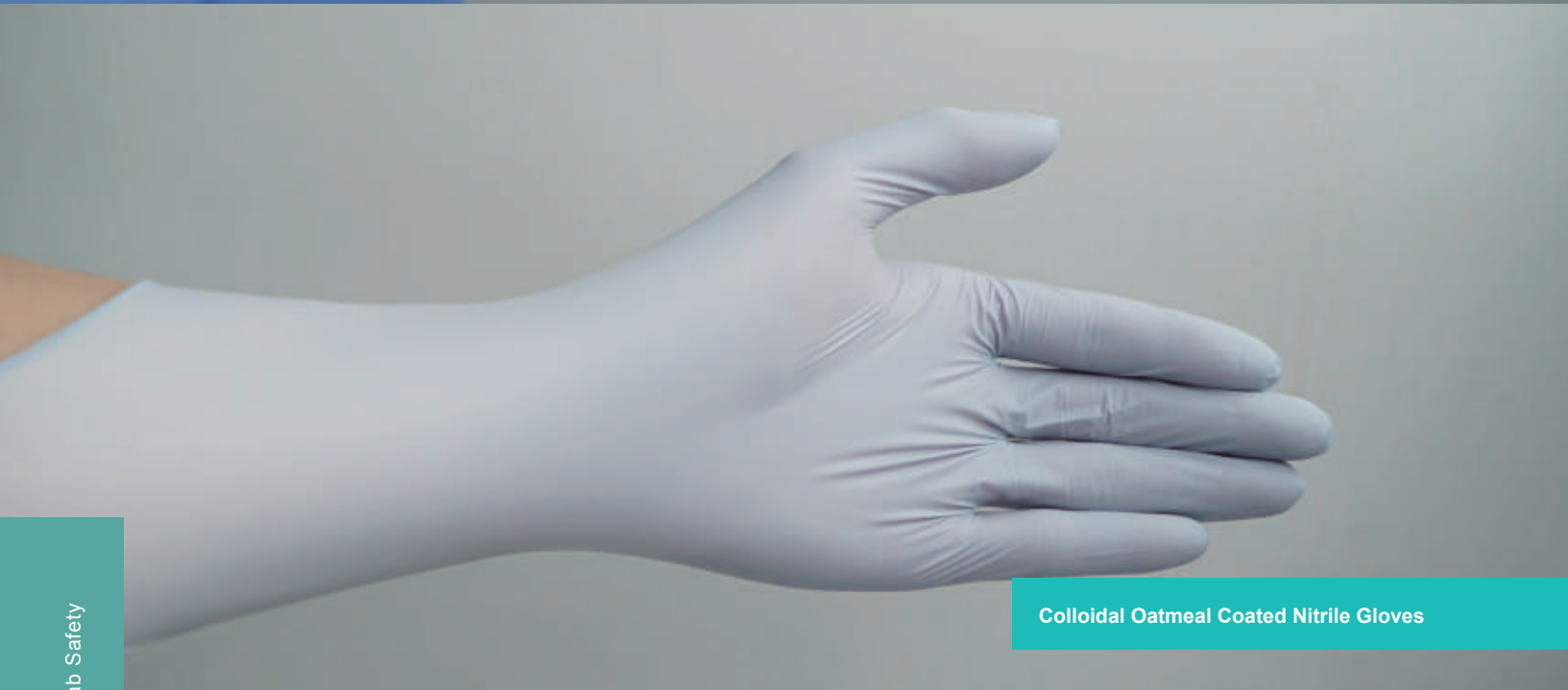

Colloidal Oatmeal Coated Nitrile Gloves

Feature

- Made of nitrile, an alternative solution for people allergic to natural latex.
- Suitable for both left and right hand.
- Tensile Strength: Minimum 18.0 MPa (Before Aging).
- Rolled cuff design makes it easy to wear and prevents rollback.
- Textured fingertips increase friction for better gripping.
- Powder-free.
- Non-Sterile. Single use only, powder free.
- Boxed pull-out packaging.
- Made in Malaysia.
- Powder-free nitrile gloves weigh 3.5 grams.



• Colloidal Oatmeal Coated Nitrile Glove

Oats Extractions

Oats extractions is a patented coating recognized by the FDA as a skin protectant, which have been proven by clinical studies could reduce and control rash and dry skin symptoms. Clinical studies have shown that colloidal oatmeal could reduce and control rash, dry skin.



Moisturizing

Keep skin moist through its moisture-locking capacity



Anti-Oxidation

Protects skin from oxidative damage



Protect

Forms an adhesive, closed barrier to protect skin from external stimuli



Restoring pH

Maintains skin's protective barrier function by restoring pH balance



Soothing

Relieves inflammation, irritation and itchiness and boosts skin's restoration process



Clean

Acts as a natural cleanser to remove dead skin cells

Cat.No.	Size	Palm Width (mm)±4 mm	Length (mm)	/Pack	/Case
903001	XS	76	≥230	100	1000
903011	S	84		100	1000
903021	M	94		100	1000
903031	L	105		100	1000

• Nitrile Powder Free Examination Glove

Cat.No.	Size	Palm Width (mm)±4 mm	Length (mm)	/Pack	/Case
902001	XS	76	≥230	100	1000
902011	S	86		100	1000
902021	M	98		100	1000
902031	L	107		100	1000
902041	XL	115		90	900

• Nitrile Powder Free Examination Glove

Cat.No.	Size	Palm Width (mm)±5 mm	Length (mm)	/Pack	/Case
902101	XS	≤80	≥230	100	1000
902111	S	80		100	1000
902121	M	95		100	1000
902131	L	110		100	1000
902141	XL	≥110		90	900

Latex Examination Glove



Latex Powder Free Examination Gloves



Colloidal Oatmeal Coated Latex Gloves

Feature



- Made of synthetic latex.
- Suitable for both left and right hand.
- Tensile Strength: Minimum 18.0 MPa (Before Aging).
- Rolled cuff design makes it easy to wear and prevents rollback.
- Textured fingertips increase friction for better gripping.
- Powder-free.
- Non-Sterile. Single use only, powder free.
- Boxed pull-out packaging.
- Made in Malaysia.
- Powder-free latex gloves weigh 5.5 grams.

● Colloidal Oatmeal Coated Latex Glove

Oats extractions is a patented coating recognized by the FDA as a skin protectant. Clinical studies have shown that colloidal oatmeal could reduce and control rash, dry skin symptoms.



Moisturizing

Keep skin moist through its moisture-locking capacity



Anti-Oxidation

Protects skin from oxidative damage



Protect

Forms an adhesive, closed barrier to protect skin from external stimuli



Restoring pH

Maintains skin's protective barrier function by restoring pH balance



Soothing

Relieves inflammation, irritation and itchiness and boosts skin's restoration process



Clean

Acts as a natural cleanser to remove dead skin cells

Cat.No.	Size	Palm Width (mm)±4 mm	Length (mm)	/Pack	/Case
904001	XS	76	≥230	100	1000
904011	S	84		100	1000
904021	M	94		100	1000
904031	L	105		100	1000

Tip: Please store in a cool, dry place, and avoid direct sunlight.

● Latex Powder Free Examination Glove

Cat.No.	Size	Palm Width (mm)±4 mm	Length (mm)	/Pack	/Case
901001	XS	76	≥230	100	1000
901011	S	86		100	1000
901021	M	98		100	1000
901031	L	107		100	1000
901041	XL	115		100	1000

Nonwoven Mask



• Features

- Can filter some toxic and harmful substances, odor gases, dust, etc. in the air.
- Bendable nose clip to ensure a better fit between the mask and the face.
- Foldable, easy to store, light weight, easy to carry.
- The four-layer activated carbon protection mask is made of activated carbon fiber of high adsorption, which is more effective in filtering than the ones protection mask without activated carbon fiber.

Cat.No.	Name	Size (±0.5cm)	Color	/Pack	/Case
922001	Three-layer PP Non-woven Lab Protection Mask	17.5 x 9	Blue	50	500
922101	Four-layer PP Activated Carbon Non-woven Lab Protection Mask	17.8 x 9.3	Dark Gray	50	500

Mushroom Cap & Non-woven Shoe Cover

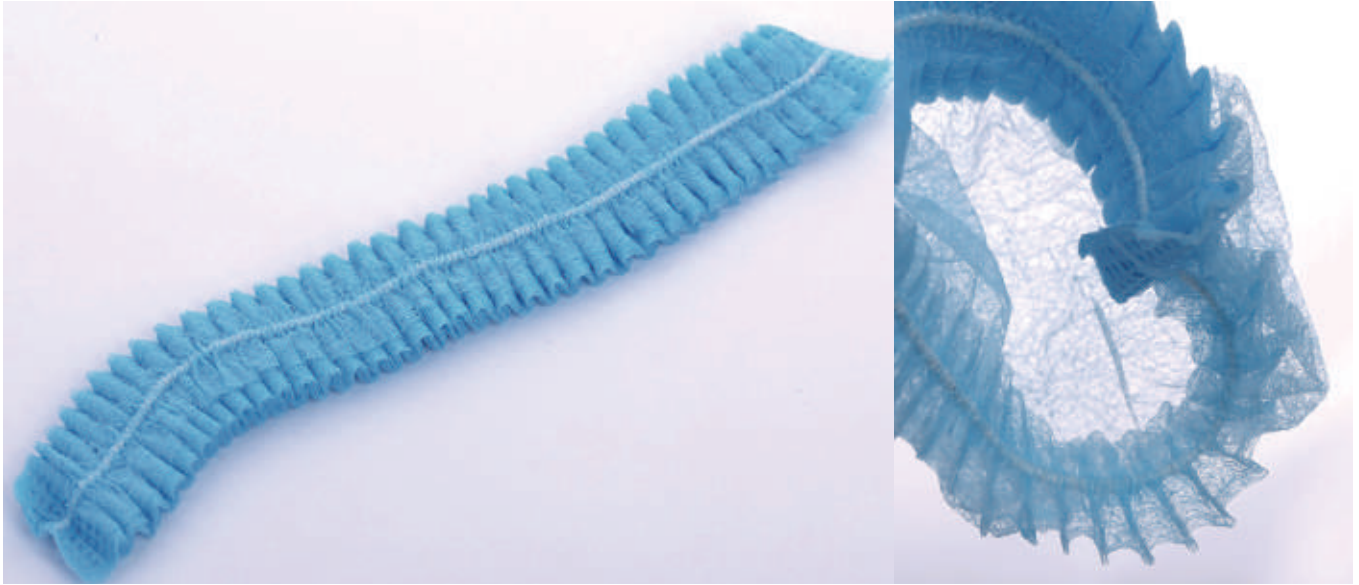

• Features

- Breathable, dustproof, able to block dust and microorganisms.
- Not feeling tight for long-time wearing, no allergic reaction.

Cat. No.	Name	/Pack	/Case
921001	Blue Mushroom Cap	100	1,000



• Features

- Breathable, non-slip, with rubber bands, comfortable to wear.

Cat. No.	Size(cm)	/Pack	/Case
923001	42 * 17	100	1,000



We, TongRo Image Stock, since commence with producing digital image slide transparency business in 1992, have been building outstanding success.

Lab Instrument

7° Digital Nutating Mixer

• Features

- The adjustable and gentle motion is ideal for many staining applications;
- Includes a large platform and non-slip mat;
- Low voltage power supply provides safe cold room operation and low energy consumption;
- Continuous or timed operation with automatic switch-off;
- Continue to run by last set speed and the remaining time when the power recovers;
- Audible and visual alarm: In timed mode, alarm will sound 5 times and then the time window shows "End" and flicker 5 times when the time reaches zero.

Cat. No.	105005
Speed	2~80rpm
Speed Accuracy	1rpm
Tilt Angle	7°
Timer	0~99h59min
Platform Dimensions	307x297mm
Max. Load	0.8kg
Display	LED
Included Accessory Standard in Packaging	6 Rubber Strips
Ambient Temperature	5~40 C
Relative Humidity	≤80%
Power Supply	AC100~240V, 50 / 60Hz
Max. Power	6.5W
Dimensions	440(L)x296(W)x189(H)mm
Net Weight	7.3kgs
Protection Level	IP21



Rubber Strip

Mini Vortex Mixer

• Features

- Extremely compact and easy operate;
- Powerful vortex for tubes up to 30mm;
- Head is made of durable material to ensure long life;
- Refined steel base is designed to ensure product stability.

Cat. No.	105003
Oscillation Mode	Circumference Oscillation
Orbital Diameter	Φ4.5mm
Max. Capacity	80mL
Max. Tube Diameter	Φ30mm
Speed	3000rpm
IP rating (DIN EN 60529)	IP40
Ambient Temp.	5~40 C
Outside Dimensions	Φ96xH85mm
Power	5W
Power Supply	AC100~240V,50/60Hz
Weight	0.55kg



Variable Speed Tube Revolver with Digital Display



Rotisserie Paddles
For 10mL / 15mL Tubes



Rotisserie Paddles
For 1.5mL / 2mL Tubes



Rotisserie Paddles
For 5mL / 7mL Tubes



Rotisserie Paddles
For 0.5mL / 0.8mL Tubes

• Features

- Small footprint, "Plug and Play" operation;
- Includes five different interchangeable rotisseries;
- Rotation direction can be changed by slightly touching the rotisseries;
- Paddle angle is adjustable for different purposes;
- High quality, maintenance-free motor with little noise.



Rotisserie Paddles
For 50mL Tubes

Cat. No.	105004
Rotation Speed	10~40rpm
Capacity	84x0.5mL tubes, 60x1.5mL / 2.0mL tubes, 28x5mL / 7mL tubes, 24x10mL tubes, 6x50mL tubes
Holder for Tubes Standard Configuration	Rotisserie Paddles for 10mL / 15mL Tubes 2pcs Rotisserie Paddles for 5mL / 7mL Tubes 2pcs Rotisserie Paddles for 1.5mL / 2mL Tubes 2pcs Rotisserie Paddles for 0.5mL / 0.8mL Tubes 2pcs Rotisserie Paddles for 50mL Tubes 1pcs
Ambient	4~60 C
Outside Dimensions	260(W)x148(D)x195mm(H)
Power	10W
Power Supply	AC100V~240V 50Hz/60Hz
Weight	1kg

CO₂ Orbital Shaker

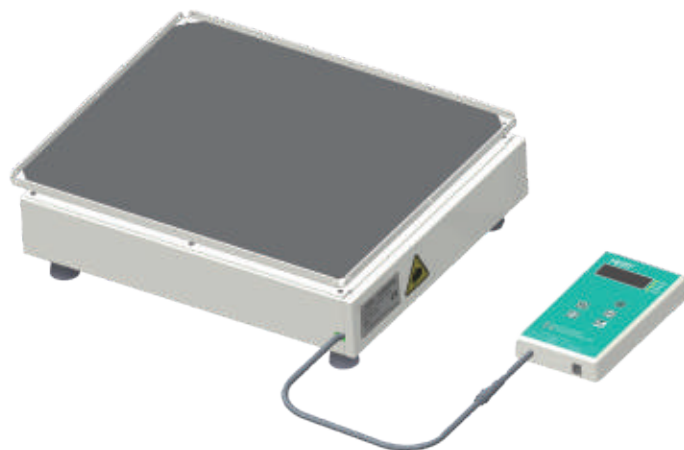

● Features

- Orbital shaking through magnetic power eliminates the need to replace belts;
- Small footprint ideal for use in a CO₂ incubator;
- Specially treated mechanical components protect up to 20% CO₂ and 95% humidity conditions;
- Convenient external control box with LED display allows for easy adjustments without opening the chamber door;
- Minimal heat dissipation assures conditions within the CO₂ chamber are not effected;
- CO₂ resistant shaker can be used outside of CO₂ incubator for maximum value.

Cat. No.	105008 (No Accessories) / 105009 (Contains Accessories)
Speed Range	30rpm~300rpm
Timer	0~99h59min (0, continuous)
Orbit Diameter	Φ19mm
Platform Dimensions	355mmx300mm
Max.Capacity	50mL x30 / 100mL x15 / 150mL x15 / 200mL x15 / 250mL x15 500mL x9 / 1000mL x6 / 2000mL x4 / 3000mL x2 / 5000mL x1
Display	LED
Max.Load	6kgs
Ambient	Temp.: 5 ~ 60 Humidity: <99%RH
Outside Dimensions (WxDxH)	Machine Body: 360 x 300 x 96mm Control Box: 360 x 105 x 75mm The Unit: 360 x 405 x 96mm
Power	30W
Power Supply	AC100~240V, 50Hz/60Hz
Weight	Machine Body :17.5kgs Control box: 1kg

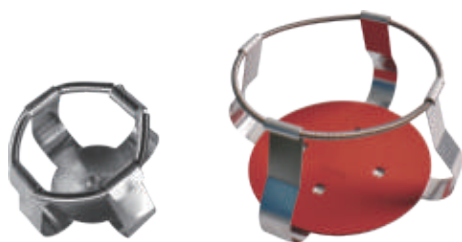

Flask Clamp



Aluminum Platform

● Flask clamp feature

Made of polished stainless steel. They can be fixed on any platform of all models of incubator shakers.

Cat.No.	Name
105901 ▲	100mL Flask Clamp * 2
	250mL Flask Clamp * 4
	500mL Flask Clamp * 4
	1000mL Flask Clamp * 2
	2000mL Flask Clamp * 2
	Aluminum Platform * 1
105902 ▲	100mL Flask Clamp
105903 ▲	250mL Flask Clamp
105904 ▲	500mL Flask Clamp
105905 ▲	1000mL Flask Clamp
105906 ▲	2000mL Flask Clamp
105907 ▲	Aluminum Platform 300mm*360mm

▲ Make to Order

Standard Mini Roller



Standard Mini Roller (6 Rollers)



Control Box

Standard Mini Roller (11 Rollers)

• Features

- Variable speed to accommodate numerous applications.
- Anti-corrosive and wear-resistant construction for use in humid and CO₂ environments.
- Remote control box makes it easy to operate the unit while it is in an incubator.

Product Name	Standard Mini Roller (11 Rollers)	Standard Mini Roller (6 Rollers)
Cat. No.	105007	105006
Included Accessory Standard in Packaging	Rollers: 11 O Ring (23.5x3.6mm): 20 O Ring (13.2x2.7mm): 20	Rollers: 6 O Ring (23.5x3.6mm): 20 O Ring (13.2x2.7mm): 20
Roller Speed	0.5~80rpm	0.5~80rpm
Operating Mode	Way forward	Way forward
Roller Dimensions (DXL)	Φ28mmx259mm	φ28mmx259mm
Available Tubes or Bottles	Max. Ø120mm bottles; tubes	Max. Ø120mm bottles; tubes
Positions	Centrifuge tubes can be placed randomly or three 1500ml standard bottles	Centrifuge tubes can be placed randomly or three 1500ml standard bottles
Max. Load	6.5kgs	6.5kgs
Ambient	5°C~60°C	5°C~60°C
Relative Humidity	≤95%	≤95%
Display	LED	LED
Timer (Control Box)	999min or continuous	/
Outside Dimensions (WxDxH)	378mmx360mmx72mm	378mmx360mmx72mm
Power	10w	10W
Power Supply	AC100~240V,50/60Hz	AC100~240V,50/60Hz
Weight	6.5kgs	6.5kgs

Automatic Decapper Instruction manual



● Product Introduction

The device is equipped with the functions of automatic capping g/uncapping and automatic counting, which is small and light, out of ergonomic inclination design. It is of ergonomic inclination design, small and light. With a single hand holding the tube, automatic capping/uncapping can be realized, effectively reducing the working intensity of testers and greatly improving the working efficiency.

● Features

Flexible & Easy-to-use Multiple working modes available (Continuous uncapping; continuous capping; and capping after uncapping), The device can customize the parameters such as torque, clamping force and number of turns to avoid sealing failure and prevent sample contamination.

Intelligent & Efficient The device is fitted with a high-safety automatic trigger starting mechanism, without need for manual trigger of key, The processing speed less than 4s/sample.

Compatible The device is suitable for the sampling tubes with screw caps(the cap diameter is 8-22mm) and can be customized for other sizes.

Safe & Portable The software interface is simple and easy to understand, with counting display, counting re-set and module re-set functions. With a small size, it is flexible to move and can be used in the working scenarios such as biosafety cabinet and super clean bench, and disinfectant like alcohol can be used to directly spray for disinfection.

Product Model	European / German standard plug	British standard plug	South Africa / India standard plug	American standard plug
Cat.No.	107001	107002	107003	107004
Clamping force	40-150N			
Capping/torque	1N*m			
Starting mode	Push up the tube to automatically trigger the startup			
Working mode	Continuous uncapping; continuous capping; and capping after uncapping			
Settable functions	Torque, clamping force, number of turns, uncapping mode			
Applicable specifications	The sampling tubes with screw caps (the cap diameter is 8-22mm)			
Weight	10 kgs			
Dimensions	250mm×245mm×420mm			

● Application sites



● Application scenarios

1 Sample collection link
(Sample collection for COVID-2019 testing)

2 Sampling and testing link
(Sampling for COVID-2019 testing)

3 Packaging
(Reagent packaging)

Centrifuge

• Feature

- Electronic locks. Centrifugation only when the lid is locked.
- The lid opens automatically after centrifugation.
- Fast Lifting Speed, the electronic brake.
- Low Noise.
- Capacitive touchpad, responsive.
- LCD display. Real-time display of speed, time and operating status.
- Centrifugal time and speed adjustable. Adjustable speed during centrifugation.
- Size: 260*220*150mm.
- Voltage: 110-220V, 50-60HZ.

Type	Name	Centrifuge Range (RPM)	Max RCF (g)	Rotor
102001	Universal Centrifuge	500-6,000	2,400	General Rotor (1.2/0.5/1.5/5.0ml)
102002	5 mL Centrifuge	500-6,000	2,400	For 5 mL Centrifuge Tubes
102101	High - Speed Centrifuge	500-12,000	8,800	For 1.5 mL & 2.0 mL Centrifuge Tubes



General Rotor



5 mL Centrifuge



High - Speed
Centrifuge

Mini Dry Bath

• Feature

- Manual mode & automatic mode.
- Fast heating, with overheat protection switch to prevent overheating.
- Display setting parameters and real-time parameters simultaneously, easy to observe and use.

Range of Application	0.2/0.5/1.5/2.0ml Centrifuge tube
Temperature Range	Indoor temperature-100 C
Time set	1-999min or 1-999sec
Temperature control accuracy	±0.1 C
Temperature uniformity	±0.3 C
Heating up time	About 5min
Touch screen	Capacitive touch screen
Display	LCD
Voltage	100-220V, 50-60HZ
Size	157*115*100mm (L*W*H)
Weight	About 0.5kg



Label Printer



● BradyPrinter i5100 Label Printer

Brady i5100 label printer supports batch printing and integrates intelligent printing technology, making various complex printing tasks within your enterprise easier to accomplish.

● Product Performance Advantages:

- Simple settings changes: The touch screen is easy to use for adjusting printer settings quickly.
- Comprehensive feature set: The printer has all the features needed for high-performance printing.
- Intelligent Printing (IP) technology: Software and consumables that communicate with the printer eliminate debugging after consumable replacement and allow you to get back to work quickly.
- Intelligent loading design: Specially designed ribbon rewind spools and automatic centering label roll holders make consumables easy to replace without additional steps.
- Multiple hardware options: You can use a variety of connection ports to connect to the devices you need and use replaceable rubber rollers to optimize printing effects for different labels.

Model	I5100
Handheld/Desktop	Desktop
Power Supply	100 - 240V AC, 50/60 Hz, PFC
Printing Method	Thermal transfer (300 or 600dpi) / direct thermal (300dpi - depending on material and printhead)
Printing Resolution	300 dpi / 600 dpi
Maximum Printing Width	4.16 inches (106mm)
Maximum Label Width	0.20 inches (5mm) to 4.33 inches (110mm)
Maximum Printing Speed	Maximum 11.8 inches (300mm)/second (300 dpi) Maximum 5.9 inches (150mm)/second (600 dpi)
Printing Color	Single color

Memory	256MB
Connectable to Computer	Yes
Interfaces	USB 2.0, RS232-C, Ethernet 10/100 BASE-T, SD slot
Keyboard	External
Display Screen	Color LCD touch screen
Dimensions	12.5 inches (318mm) x 9.5 inches (241mm) x 17.1 inches (434mm)
Weigh	14.6 pounds (6.6kg)
Maximum Power Consumption	Standby <10W / Normal 150W / Maximum 300W
Software	Brady Workstation (v4.1 or higher) and Workstation applications, Brady LabelMark software (v6.6.1 or higher)

Consumables Number	106091	106092
Consumables Name	Cryogenic Labels	Thermo Ribbon
Consumables Model	THT-163-499-3127mm*37.4mm	IP-R4302
Packaging	3000 pcs/roll	1 roll/box

Sample Management Software

NEST Sample Management System (SMS) is a comprehensive sample information management system for laboratories, medical units, and scientific research institutions. It streamlines multiple steps in the sample information process, including pre-processing, storage, queries. NEST SMS supports custom configurations according to on-site needs, without the need for special customization development. It links functional modules efficiently, ensuring simple and smooth inbound and outbound steps, complete information, and reducing the workload and human error risks associated with sample library management.

Software highlights

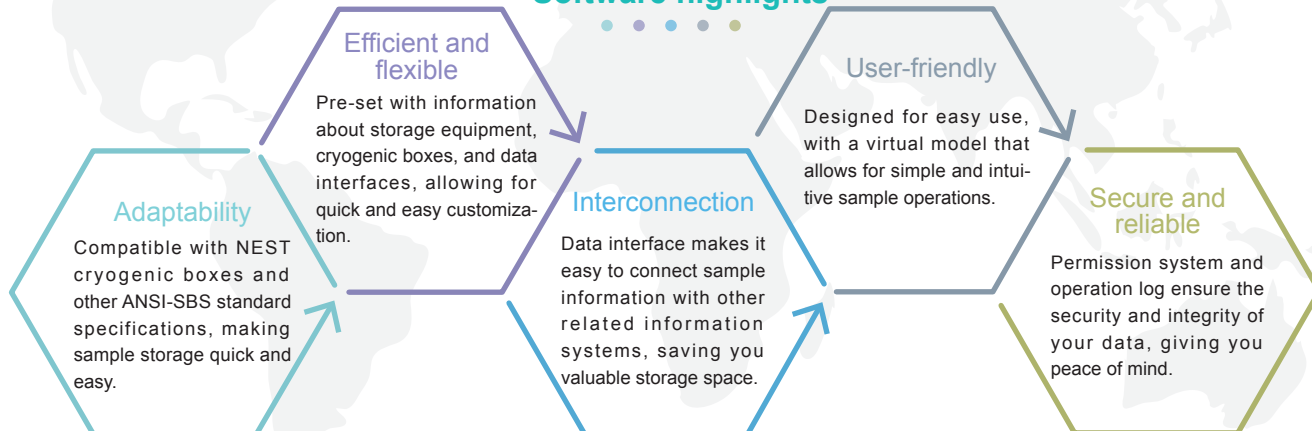

Basic Functional Modules

- Regional equipment: visual equipment structure overview
- Sample management: custom, pre-entry, sample storage and retrieval
- Query and statistics: query and statistics of samples by location, custom fields, association information, and scanning
- Data management: data backup, batch editing of samples
- Associated information: can be docked with HIS, LIS, PACS, and other information systems to quickly improve sample information and save local space
- Label printing: human-readable barcodes and custom adhesive labels can be added
- Settings: custom storage equipment (refrigerator, liquid nitrogen tank, freezer rack, cryogenic box), custom sample information, user role settings, etc.

Advanced Functions

- Pre-set SQL Server, Oracle, MySQL data interface
- Quick association pre-entry
- Custom sample number, encoding rule settings
- User permission management, log information inquiry
- Label printing scene settings.



Product Number	Product Specification
106131	NEST Sample Management Software-20 terminal devices
106132	NEST Sample Management Software-15 terminal devices
106133	NEST Sample Management Software-10 terminal devices
106134	NEST Sample Management Software-5 terminal devices
106135	NEST Sample Management Software-3 terminal devices

Single-Rack Reader

The NEST Single-rack reader is a device that rapidly decodes entire boxes of biological samples in biobanks and high-throughput laboratories. It is lightweight, compact, and can quickly decode various types of cryogenic boxes on-site. The device can simultaneously decode the entire box and read the cryogenic box code. When used with the NEST sample management software, it can directly decode and store entire boxes of samples. The device was gr:

● Cryogenic box plate rack

Decoding entire boxes of cryogenic tubes

- Decoding rules can be customized according to the cryogenic box specification (8*12, 6*8, 5*5, 9*9, 10*10, etc.)
- Non-standard decoding area can be specified for each position.

Cryogenic box code

- Can be a one-dimensional or two-dimensional barcode on any side of the cryogenic box or a two-dimensional code at a certain position on the bottom of the cryogenic box.
- Cryogenic box code decoding does not require an external device.
- Cryogenic box code location can be automatically set by software.



● Data interface

- Enabling data integration with systems such as HIS, LIS, PACS, EMR, etc.
- Open database interface can be implemented through the pre-configured Oracle, SQL Server, MySQL of the system without the need for customized development.

● Matching software and interface services

- Operating system: Windows XP or higher version.
- One-click cryogenic box numbering and entire box cryogenic tube decoding.
- Cryogenic box template can be customized.
- Decoding results can be displayed through graphics, lists, and images.
- Decoding results can be exported to Excel files.
- HTTP service interface can be started with one-click to automatically generate URL addresses.
- HTTP service call return results consistent with the direct software interface operation results.

● Mainframe framework

- Small and portable size: 220*175*220mm (length * width * height).
- Light weight: about 1.5 kg.
- Operating environment -20°C ~ 35°C.

● Camera

- Dust-proof and waterproof tempered glass protection above the camera
- Plug and play, no need to install drivers.



● USB data cable/power switch

- Standard USB2.0 interface, no external power supply required, low power consumption (1W-4W).
- Standby power consumption less than 1W, and photo decoding power consumption is less than 4W.

Product number	106211
Product model	Single-rack reader NSSnap, English

Multi-Rack Reader

Multi-Rack Reader

- Partial scanning according to the number of cryogenic boxes.
- Scanning results in various ways such as graphics, lists, and images.
- Full-frame decoding less than 10 seconds, single-box scanning within 3-5 seconds.
- Excel export of a single box or merged multiple boxes.
- Decoding application for scanning bottom QR codes for integration (single-rack/multi-rack) based on the Windows system.
- Fast scanning of inbound and outbound barcodes, greatly improving work efficiency.
- Number and type of cryogenic boxes customization.
- Compatible with major brands of cryogenic tubes on the market.
- Compatible with various scanning racks to meet different quantity requirements.



Product number	106212
Product model	Multi-rack reader NSScanner, English
Product type	Flatbed
Maximum scanning range	216×297mm
Scanning component	CCD
Optical resolution	4800×9600dpi
Scanning speed	Full-frame scanning ≤ 6 seconds

Scanning light source	LED light source
Rack types	SBS box + traditional square box, 2 traditional square boxes, 3 SBS boxes
Product size and weight	443.5×278.6×54mm 2.14kg
Power/power consumption	220V/18W
Data interface	Provides HTTP access service to return a JSON string containing the position and cryogenic tube code
Support system	Windows2000/XP/Vista/7/10
Machine brand	EPSON

Barcode Scanner

The barcode and DATAMATRIX code on the cryogenic tube can be scanned using a barcode scanner to quickly obtain information related to the sample.

The scanning result can be directly input into the sample library management system, facilitating the subsequent sample tracking and management.

The barcode scanner has the following features: high efficiency, high accuracy, easy to operate, and strong durability.

- Quick recognition of electronic screen codes: can scan one-dimensional and two-dimensional codes and traditional paper barcodes, and has strong decoding ability for electronic screen QR codes.
- High-speed rebound button: 5 million fatigue tests, still maintaining good button effects.
- Adaptus6.0 imaging technology: upgraded barcode image acquisition technology combined with custom sensors to achieve extended depth of field and fast reading.
- Sturdy and durable shell: using a new generation of high-strength ABS materials, it can withstand a 1.5m free fall impact.
- Classic commercial appearance: loved by international brands, simple and versatile design, naturally formed.



Handheld Decapper for Cryogenic Vials



● Product introduction

NEST decapper is available in 1, 8, 24, 48, and 96 channel models, suitable for use in biobanks, genetic sequencing, disease control centers, blood centers, laboratory automation, pharmaceuticals, and other industries.

● Features

- Improved efficiency: significantly improves efficiency compared to manual operations
- Safety requirements: prevents laboratory personnel from contacting samples or reagents when opening or closing caps, reducing the risk of biological and chemical hazards.
- Sealing guarantee: the uniform torque design of the automated decapper prevents caps from being closed improperly or damaging the cryogenic vial due to uneven hand force.
- Wide compatibility: easily opens and closes all NEST 2D barcode cryogenic vials, and is also suitable for other brands with the same cap clasping mechanism.

● Product parameters

Product name	Handheld Decapper for Cryogenic Vials
Product number	106002
Empty load speed	170rpm
Manual torque	2N.m
Electric torque	0.25-0.35N.m
Battery type	Lithium battery
Battery voltage	3.7V
Battery capacity	260mAh
Charging time	45 minutes

Cell Thawing Device



● Product Introduction

To better meet the needs of applications with small sample quantities and reduce user procurement costs, NEST has launched the NEST cell thawing device, which integrates real-time temperature data display. NEST cell thawing device uses "resistive heating", "programmed temperature control", "low temperature sensing" and other technologies to achieve cell thawing and resuscitation. The built-in temperature monitoring system identifies the surface temperature of cryogenic tubes and each stage temperature during the solid-to-liquid thawing and resuscitation process. Even if there are frozen storage labels and marker pens on the surface, the thawing effect will not be affected. Customizable thawing and recovery solutions for all types of frozen cell storage tubes, whether they are stored in liquid nitrogen or at -80°C.

The thawing time of the NEST cell thawing device is basically the same as that of a water bath. It takes 1 minute to preheat, about 1 minute and 10 seconds for the melting stage, and about 1 minute and 20 seconds for the thawing and resuscitation stage. The cell survival rate of thawing and resuscitation is similar to that of a water bath.

Product Name	NEST Cell Thawing Device
SKU	106007
Model	LA-G002
Throughput	2 holes, each hole can be used independently
Application	2.0ml standard cryogenic tubes
Filling volume	0.8-1.5ml
Thawing time	3 minutes
Alarm	Low temperature alarm, error operation alarm
Prompt sound	Preheating end prompt, thawing countdown prompt, thawing end prompt
Thawing and resuscitation end	Cryogenic tube pops out directly
Size (L * W * H)	23 * 14 * 16cm
Weight	3.5kg
Voltage	220V, 50Hz
Warranty	One-year warranty for the whole device

● Product Features

- Small size, less space on the workbench.
- Especially suitable for scenarios with few samples to be thawed and resuscitated.
- The LCD screen can display the real-time temperature of the sample.
- Has account management and data export functions
- Comes with a transfer container for transferring cryogenic tubes.

● Operating procedures



01 Power on



02 Insert the cryogenic tube into the hole



03 The thawing instrument automatically thaws



03 After thawing is complete, the cryogenic tube pops out

Pipette

121°C
FULLY
Autoclavable

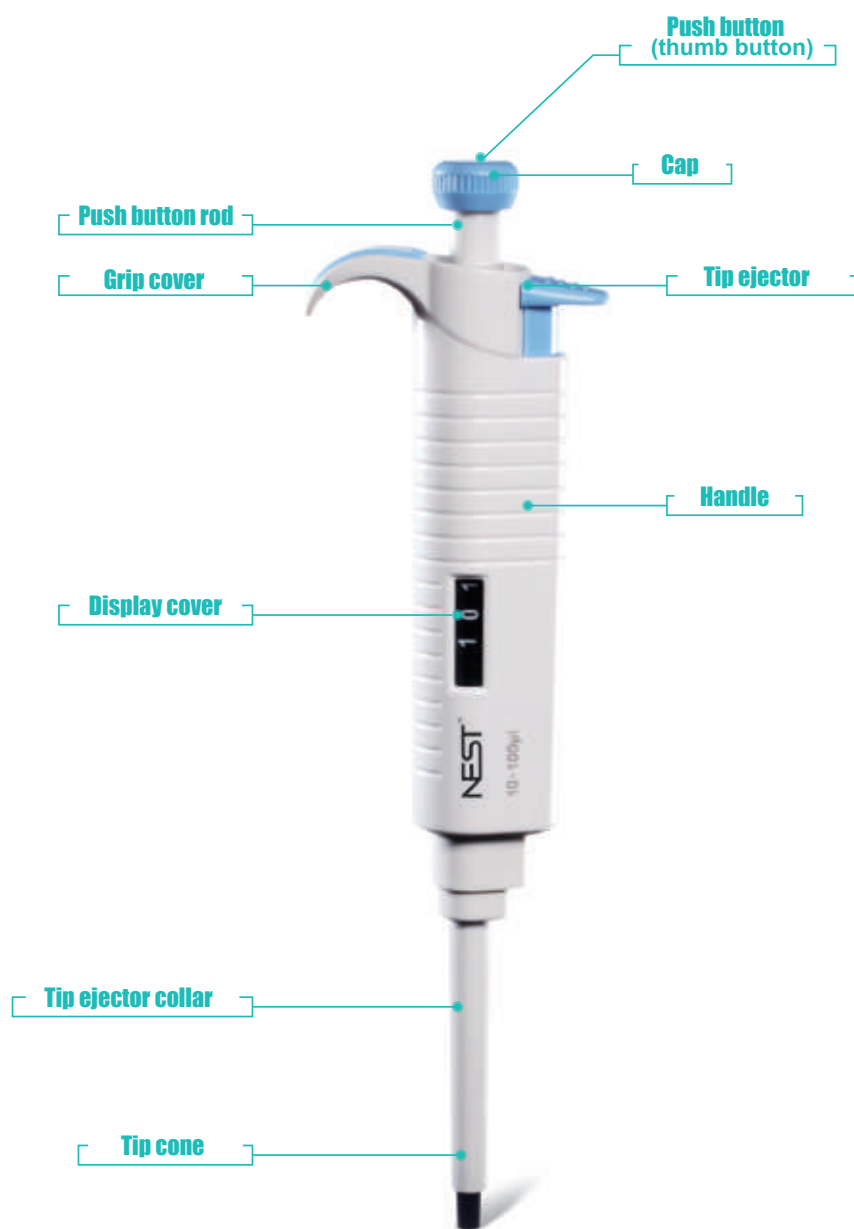

● Features

- Available as Fixed Volume and Adjustable Volume formats.
- Streamlined shape design.
- Comprehensive volume range from 0.1 µL to 10mL.
- Easy calibration and maintenance.
- 8 and 12 channel pipette options.
- Dispensing head rotates for effortless pipetting convenience.
- Individual piston and tip cone assembly.
- Spring loaded tip cones for easy cleaning and maintenance.
- Compound material-made tip cone secures high sealing performance.



Mechanical Pipette Volume Selection

Specifications This volume list is for MicroPette and MicroPette plus (Adjustable volume)

Single-channel Adjustable Volume Pipettes							
Cat.No.	Volume Range	Increment	Test Volume	Error limits in accordance with ISO8655-2			
				Systematic Error		Random Error	
				μL	%	μL	%
104011	0.1-2.5	0.05	2.5	±0.0625	±2.50	±0.05	±2.00
			1.25	±0.0375	±3.00	±0.0375	±3.00
			0.25	±0.03	±12.00	±0.015	±6.00
104012	0.5-10	0.1	10	±0.1	±1.00	±0.08	±0.80
			5	±0.075	±1.50	±0.075	±1.50
			1	±0.025	±2.50	±0.015	±1.50
104013	2-20	0.5	20	±0.18	±0.09	±0.08	±0.04
			10	±0.12	±1.20	±0.1	±1.00
			2	±0.06	±3.00	±0.04	±2.00
104014	5-50	0.5	50	±0.3	±0.60	±0.15	±0.30
			25	±0.225	±0.90	±0.15	±0.60
			5	±0.1	±2.00	±0.1	±2.00
104015	10-100	1	100	±0.8	±0.80	±0.15	±0.15
			50	±0.5	±1.00	±0.2	±0.40
			10	±0.3	±3.00	±0.15	±1.50
104016	20-200	1	200	±1.2	±0.60	±0.3	±0.15
			100	±0.8	±0.80	±0.3	±0.30
			20	±0.6	±3.00	±0.2	±1.00
104017	100-1000	5	1000	±6	±0.60	±2	±0.20
			500	±3.5	±0.70	±1.25	±0.25
			100	±2	±2.00	±0.7	±0.70

User calibration should refer to the industrial standard ISO8655-2.

Bulk, Non-sterile	Racked, Sterile	Product Description	0.1-2.5μL 104011	0.5-10μL 104012	2-20μL 104013	5-50μL 104014	10-100μL 104015	20-200μL 104016	100-1000μL 104017
—	314016	10μL filter universal pipette tips, extra long, clear	✓	✓					
314001	—	10μL universal pipette tips, extra long, clear	✓	✓					
—	311012	10μL filter universal pipette tips, clear	✓	✓					
311001	—	10μL filter universal pipette tips, clear	✓	■					
301006	301016	10μL universal pipette tips, clear	✓	✓					
—	310012	20μL filter universal pipette tips, clear			✓				
316001	316012	100μL filter universal pipette tips, clear				✓	✓		
312001	312012	200μL filter universal pipette tips, clear					✓	✓	
302106	302116	200μL universal pipette tips, yellow			✓	✓	✓	✓	
305006	305016	300μL universal pipette tips, clear			✓	✓	✓	✓	
313001	313012	1000μL filter universal pipette tips, extra long, clear							✓
303206	303216	1000μL universal pipette tips, blue							✓
304006	304016	1250μL universal pipette tips, clear							✓

■ Note: Due to the easy loosening of the filter of the bag-packaged tips, there may be a situation of not fitting in this combination. Not recommended.

CHEMICAL RESISTANCE CHART

	ABS	Acetal	HDPE	LDPE	PC	PP	Santo-prene	Sili-cone	Reagent	ABS	Acetal	HDPE	LDPE	PC	PP	Santo-prene	Sili-cone
Acetaldehyde	D	A	C	C	C ¹	A ¹	-	A	Benzene	D	A ¹	D	D	D	D	D	D
Acetamide	-	A	A	A	D	A ¹	-	B	Benzene Sulfonic Acid	-	-	A	A ¹	D	D	-	D
Acetate Solvent	-	-	A	A	-	B ¹	-	C	Benzoic Acid	-	B	A	A ¹	D	D	-	D
Acetic Acid	D	D	A	A ²	B ¹	A	A	C	Benzol	D	A	-	C ¹	B ¹	D	-	D
Acetic Acid 20%	C	C	A	A ²	A ¹	A	A	B	Benzonitrile	-	-	-	-	A ¹	-	-	A ¹
Acetic Acid 80%	D	D	A	D	B ¹	A	C	B	Benzyl Chloride	D	A	-	-	-	C ¹	-	D
Acetic Acid, Glacial	D	A	D	B ¹	A ¹	D	B	-	Bleach	B	D	-	-	-	D	-	-
Acetic Acid, Vapors	-	-	-	-	-	-	-	A	Bleaching Liquors	-	-	-	A ¹	-	-	-	B
Acetic Anhydride	C ¹	D	C	D	D	B ¹	D	C	Borax (Sodium Borate)	-	B	A	A ²	A ¹	B	-	B
Acetone, 50% water	D	-	-	-	-	A	-	A ²	Boric Acid	-	A	A	A ²	-	A	A	A
Acetone	D	A	D	B ¹	D	A	A	D	Brewery Slop	-	B	-	-	-	-	-	-
Acetonitrile	D	-	A	B ¹	D	A ¹	D	D	Bromine	D	D	D	D	C ¹	D	-	D
Acetophenone	-	-	C	D	D	C	-	-	Bromofom	-	-	D	D	D	D	-	-
Acetyl Bromide	-	-	-	D	-	-	-	-	Butadiene	-	A	D	D	D	C	-	D
Acetyl Chloride (dry)	D	D	-	D	D	D	A	C	Butane	B	A	-	C ¹	D	A ¹	-	D
Acetylene	-	A	-	D	D	A ¹	-	B	Butanol (Butyl Alcohol)	-	A	-	B ²	B ¹	A ¹	-	B
Acrylonitrile	D	-	A	A	D	A ¹	D	D	Butter	B	A	-	-	-	D	-	B
Adipic Acid	-	-	A	A	-	B ²	-	-	Buttermilk	B	A	-	A ¹	A ¹	A ¹	-	A
Alanine	-	-	A	A	A	A	-	-	Butyl Amine	-	C ¹	-	C ¹	D	B ¹	-	B ¹
- Benzyl	A ¹	A	A	B ²	B ¹	B ¹	A	D	Butyl Ether	-	-	-	-	D	D	-	D
- Butyl	A ¹	A	-	A	A ²	A	D	B	Butyl Phthalate	-	-	A	B	C ¹	B ²	-	A ¹
- Diacetone	-	A	A	B ¹	-	B ²	-	D	Butyl acetate	-	-	-	-	D	B ¹	-	D
- Ethyl	B ¹	A ¹	A	A	B ²	A	A	B	Butylene	-	A	-	B ¹	D	D	-	D
- Hexyl	-	A	-	A	-	-	-	B	Butyric Acid	D	A	D	D	D	B ¹	A	D
- Isobutyl	B	A	A	A ²	-	A ¹	-	A	Calcium Bisulfate	-	-	-	-	D	-	-	C
- Isopropyl	-	A	A	A ²	A ²	A ²	-	A	Calcium Bisulfide	-	D	-	B ¹	-	A	-	C
- Methyl	D	A	A	A ¹	B ¹	A ²	A	A	Calcium Bisulfite	-	D	A	A ¹	D	A	-	A
- Octyl	A ¹	A	-	-	-	-	-	A	Calcium Bromide 38%	-	-	-	-	-	-	-	-
- Propyl	B ¹	A	-	A ²	-	A	A	A	Calcium Carbonate	-	A	-	B ¹	C ²	A	-	A
Allyl Chloride	D	-	A	-	-	A	A	A	Calcium Chlorate	-	A	-	-	-	-	-	-
Aluminium Acetate (saturated)	-	-	-	-	-	A	-	D	Calcium Chloride (30% in water)	B	D	A	B ²	-	A ²	-	A
Aluminium Chloride	A	-	A	B ²	A ¹	A	-	B	Calcium Chloride (saturated)	A	D	A	-	-	A	-	A
Aluminium Chloride 20%	-	C	A	B ²	A ¹	A	-	B	Calcium Fluoride	-	-	-	-	-	-	-	-
Aluminium Fluoride	A	C	A	A ²	A ¹	A	-	B	Calcium Hydroxide 10%	-	A	A	-	-	A	-	A
Aluminium Hydroxide	B	A	A	A ²	B ¹	A	-	-	Calcium Hydroxide (saturated)	A	-	A	-	-	A	-	A
Aluminium Nitrate	-	B ¹	-	A ²	A ¹	A ²	-	B	Calcium Hydroxide	-	D	A	A ²	D	A ²	-	A
Aluminium Phosphate	-	-	-	-	-	-	-	A	Calcium Hypochlorite 30%	-	-	A	-	-	A	-	-
Aluminium Potassium Sulfate 10%	-	C	A	A ²	A ¹	A	-	A	Calcium Hypochlorite (saturated)	A	-	A	-	-	A	-	-
Aluminium Potassium Sulfate 100%	-	C	A	A ²	A ²	A	-	A	Calcium Hypochlorite	-	D	A	A ¹	D	A ¹	-	B
Aluminium Sulfate	A ²	B ¹	A	A ²	A	A	A	A	Calcium Nitrate	A	D	B	A ¹	A ²	A ²	-	B ¹
Alums	-	-	-	A	-	A	-	A ¹	Calcium Oxide	D	D	-	B ¹	A	A	-	-
Amines	-	D	B	C ¹	-	B ²	-	B	Calcium Sulfate	C	D	-	B ¹	A ²	A	-	-
Ammonia 10%	-	D	A	C ¹	D	A ²	-	-	Calcium Sulfide	-	-	-	-	-	A	-	-
Ammonia Nitrate	-	C	-	A	-	A	-	-	Calgon	-	A	-	-	-	A	-	A
Ammonia, anhydrous	D	D	A	B ²	D	A	-	C	Cane Juice	-	A	-	-	-	C ¹	-	A
Ammonia, liquid	-	D	A	C ¹	D	A ²	-	-	Carbolic Acid (Phenol)	D	D	-	D	D	B	-	D
Ammonium Acetate	-	-	A	A	-	-	-	-	Carbon Bisulfide	-	A	-	-	-	D	-	-
Ammonium Bifluoride	A ²	D	-	A ²	-	A	-	-	Carbon Dioxide (dry)	B	A	-	A ¹	-	A ²	-	B
Ammonium Carbonate	A ²	D	B	B ²	-	A	-	C	Carbon Dioxide (wet)	B	A	-	A ¹	-	A ²	-	B
Ammonium Caseinate	-	D	-	-	-	-	-	-	Carbon Disulfide	-	-	D	D	D	D	-	-
Ammonium Chloride	A ²	B	A	A ²	A ²	A	-	C	Carbon Monoxide	-	A	-	A ²	D	A	-	A ²
Ammonium Fluoride 25%	D	-	A	A	-	A ⁴	-	-	Carbon Tetrachloride	D	B ¹	C	D	D	D	-	D
Ammonium Hydroxide	B	C	A	A ¹	D	A	-	A	Carbon Tetrachloride (dry)	D	-	C	D	-	D	-	D
Ammonium Glycolate	-	-	A	A	B	A	-	-	Carbon Tetrachloride (wet)	D	A ¹	C	-	-	D	-	D
Ammonium Nitrate	-	A ²	A	A ¹	-	A	-	-	Carbonated Water	-	A	-	A	-	B	-	-
Ammonium Oxalate	-	B	A	-	A ¹	A	-	-	Carbonic Acid	-	B ¹	B	R ²	A ¹	A	-	A
Ammonium Persulfate	A ²	D	A	A ²	-	A	-	D	Catsup	B	B	-	-	-	A	-	-
Ammonium Phosphate, Dibasic	A ²	B ²	-	A ²	A	-	-	A	Cellulose Acetate	-	-	-	-	-	A	-	-
Ammonium Phosphate, Monobasic	-	B	-	A	A ²	A	-	A	Chloral Hydrate	A	-	D	-	-	D	-	-
Ammonium Phosphate, Tribasic	-	B	-	C	-	A	-	A	Chloric Acid	-	D	-	-	-	-	-	-
Ammonium Sulfate	A ²	B ¹	A	A ¹	A ²	A	-	A	Chlorinated Glue	-	D	-	-	-	-	-	-
Ammonium Sulfite	-	D	B	B ²	-	A	-	-	Chlorine Water	-	D	C	B ¹	D	D	-	D
Ammonium Thiosulfate	-	B	-	A	-	-	-	-	Chlorine Anhydrous Liquid	-	A ¹	C	-	C	D	-	D
Amyl Acetate	D	B ¹	-	C ¹	D	B ¹	D	D	Chlorine (dry)	-	D	B	D	D	D	-	D
Amyl Alcohol	A ¹	A	A	B ²	B ¹	B ¹	A	D	Chloroacetic Acid	-	D	A	D	D	D	-	D
Amyl Chloride	D	A	B	C	-	D	-	D	Chlorobenzene (Mono)	D	D	D	C ¹	D	C ¹	-	D
Aniline	D	A ¹	-	C	D	A ¹	D	B	Chlorobromomethane	-	-	-	A	D	A	-	D
Chloralhydrate	-	-	-	-	-	-	-	-	Chloroform	D	A	D	C ¹	D	C ¹	-	D
Aniline Hydrochloride	D	-	-	D	D	D	-	D	Chlorosulfonic Acid	-	D	D	D	C ¹	A	-	-
Antifreeze	B	D	-	-	-	D	-	C	Chocolate Syrup	-	A	-	-	-	A	-	-
Antimony Trichloride	A ²	-	B	B ²	A ²	A	A	-	Chromic Acid 5%	B	D	A	A	B	D	-	C
AquaRegia (80% HCl, 20% HNO ₃)	D	D	D	R ¹	D	B ¹	D	D	Chromic Acid 10%	B	D	A	A	B	D	-	C
Arochlor 1248	-	-	-	C ¹	-	D	-	B	Chromic Acid 30%	B	D	A	A	C	D	-	C
Aromatic Hydrocarbons	-	A	-	C	-	D	-	D	Chromic Acid 50%	D	D	A	A	D	D	-	C
Arsenic Acid	A ²	D	B	B ²	A ¹	A	B	A	Chromium Salts	-	-	-	B	-	-	-	-
Arsenic Salts	-	-	-	B	-	-	-	-	Cider	-	A	-	B	A	A	-	B ¹
Asphalt	-	B ²	-	A ¹	D	B ¹	-	D	Citric Acid	D	B ¹	A	B	A ¹	A	-	A
Barium Carbonate	A ²	A	-	B ²	A ²	A	-	-	Citric Oils	-	A	B	-	-	A	-	-
Barium Chloride	A ²	A	B	A ¹	A	A	-	A	Coffee	-	A	-	-	-	A	-	A
Barium Cyanide	-	B	-	B	-	D	-	-	Copper Chloride	A	A	-	-	-	A	-	A ¹
Barium Hydroxide	A ²	D	-	B ²	D	B	-	A	Copper Cyanide	-	A	-	B ²	D	A	-	-
Barium Nitrate	-	B ²	-	B ²	D	A	-	B	Copper Fluoborate	-	B	-	-	-	-	-	-
Barium Sulfate	A ²	B ²	B	B ²	D	B ¹	-	A	Copper Nitrate	-	A	-	B ²	D	A	-	-
Barium Sulfide	A ²	A	A	B ²	-	B	-	A	Copper Sulfate 5%	-	D	A	A ²	A	A	-	A
Beer	A ²	A ¹	A	A ²	A ²	A ¹	-	A	Copper Sulfate >5%	-	D	A	A ²	A ¹	A	-	A
Beet Sugar Liquids	B	B	-	A ¹	-	A ¹	-	A	Cream	-	A	-	-	-	-	-	-
Benzaldehyde	B	A	B	A ¹	D	D	D	D	Creosote	A	D	A	-	-	-	-	D
Benz enamine	-	-	B	A	D	A	-	-	Cresols	D	D	D	C ¹	D	D	-	D

A- No effect
B- Minor effect
C- Moderate effect

D- Severe effect;
not recommended
- No data available

Explanation of
footnotes:

- 1- Satisfactory to 72 °F (22 °C)
- 2- Satisfactory to 120 °F (48 °C)
- 3- Satisfactory to 90 °F (32 °C)
- 4- Satisfactory to 200 °F (93 °C)

USA

NEST Scientific Inc.

Tel: +1-732 381 0268

E-mail: sales@nestscientificusa.com

Website: www.nestscientificusa.com

China

Wuxi NEST Biotechnology Co., Ltd.

Tel: +86-510-6800 6788

E-mail: info@nest-wuxi.com

Website: www.cell-nest.com

Netherland

NEST Scientific Europe B.V.

E-mail: info@nestscieu.com

Website: www.nestscieu.com

United Arab Emirates

Nest Scientific MENA FZE.

E-mail: info@nestsciuae.com

Website: www.nestsciuae.com

Japan

NEST Scientific Co.,Ltd.

E-mail: info@nestscijp.com

Website: www.nestscijp.com

2023年9月版



NEST[®]



ISO 9001



ISO 13485



ISO 11137



CE



Corporate Address of USA:
3 Convery Blvd, Woodbridge, NJ 07095 USA



West Coast Address of USA:
641 S 53rd Ave, Phoenix, AZ 85043 USA



Corporate Address of China:
No. 530, Xida Road, New District, Wuxi, Jiangsu, China